



# Unit 712

## **Disclaimer**

This manual is intended as a supplement to actual hands-on instruction and is designed to teach one or more of the acceptable and recognized methods of performing specific tasks. It is not meant to be, or is it considered, an absolute or complete presentation of the procedures and safety measures related to these tasks.

Work processes and governmental safety regulations can and do change, and it is the employer's responsibility to provide workers with the most recent technical and safety information involving these processes. The guidelines and instructions presented here are not meant to supersede manufacturers' instructions or contractors' jobsite procedures, nor are they meant to replace any current local, state, provincial, or federal safety rules or regulations.

**Unit 712 – Integrated Ceiling Systems**  
**Table of Contents**

|                                      |                                     |
|--------------------------------------|-------------------------------------|
| <b>Kit Cloud Ceilings</b> .....      | 6                                   |
| Objectives:.....                     | 6                                   |
| Introduction .....                   | 6                                   |
| Kit Cloud Ceilings.....              | 6                                   |
| Shapes and Sizes .....               | 6                                   |
| Components.....                      | 8                                   |
| Main Beam .....                      | 8                                   |
| Cross Tees .....                     | 9                                   |
| Strong back.....                     | 9                                   |
| Aircraft Hanger Cable .....          | 10                                  |
| Perimeter Aluminum Trim.....         | 10                                  |
| Ceiling Tile.....                    | 11                                  |
| Kit Cloud Installation.....          | 12                                  |
| Layout.....                          | 13                                  |
| Hanger Cable Installation.....       | 15                                  |
| Installation of Strong backs.....    | 15                                  |
| Installation of Main Beams .....     | 16                                  |
| Installation of Cross Tees.....      | 17                                  |
| Installation of Aluminum Trim.....   | 20                                  |
| Squaring the Cloud.....              | 23                                  |
| Setting the Cloud to Elevation ..... | 26                                  |
| Installation of Seismic Bracing..... | 26                                  |
| Installation of Ceiling Tile .....   | 27                                  |
| Final Cleaning .....                 | 28                                  |
| Study Guide.....                     | 29                                  |
| Exercise #1 .....                    | 35                                  |
| Exercise #2 .....                    | <b>Error! Bookmark not defined.</b> |

|  |    |
|--|----|
| <b>Stick Framed Cloud Ceilings</b> .....             | 41 |
| Objectives:.....                                     | 41 |
| Introduction .....                                   | 41 |
| Stick Framed Installation – Cut-in Method .....      | 41 |
| Layout.....  | 42 |
| Hanger Wire Installation.....                        | 43 |
| Main Beam and Cross Tee Installation .....           | 44 |
| Aluminum Perimeter Trim Installation.....            | 46 |
| Stick Framed Installation – Precut Method .....      | 50 |
| Ceiling Tile Installation and Final Cleaning .....   | 52 |
| Study Guide.....                                     | 53 |
| <b>Acoustical Canopies and Vertical Blades</b> ..... | 57 |
| Objectives:.....                                     | 57 |
| Introduction .....                                   | 57 |
| Sizes and Shapes .....                               | 57 |
| Components.....                                      | 58 |
| Canopy Installation .....                            | 59 |
| Canopy Layout.....                                   | 60 |
| Hanger Cable Installation.....                       | 60 |
| Canopy Installation - Screw in Cap .....             | 61 |
| Final Adjustments and Precautions.....               | 63 |
| Canopy Installation – Spiral Anchor.....             | 64 |
| Blade Installation .....                             | 65 |
| Blade Layout – Direct Mount .....                    | 65 |
| Installation of Hanger Wire or Cable.....            | 66 |
| Installation of Blades – Direct Mount.....           | 66 |
| Blade Layout – Heavy Duty Suspension System .....    | 67 |
| Installation of Blades – Suspension System .....     | 68 |
| Study Guide.....                                     | 70 |



## Chapter 1

# Kit Cloud Ceilings

### Objectives:

Upon completion of this chapter, students will be able to:

- 1) Define the components of a kit cloud grid system.
- 2) Layout a kit cloud ceiling based on the project drawings.
- 3) Install a kit cloud grid system with ceiling tiles.

### Introduction

This chapter introduces kit cloud ceilings. Cloud ceilings can be supplied in a kit, where the components are cut to length at the factory or stick framed where the components are cut to length in the field. Both types of cloud ceilings will look the same upon completion, however, the installation procedures are different. This chapter addresses the installation of a kit cloud. Chapter 2 discusses the stick framed cloud ceiling.

Architects most often locate clouds in lobbies, auditoriums, open office areas, cafeterias and other places for visual appeal and acoustic reduction. Clouds accept a variety of ceiling tile, including wood and metal panels. The acoustic and sound absorption properties of cloud ceilings are superior to wall to wall ceilings, because cloud ceilings use both sides of the ceiling to absorb sound waves.

### Kit Cloud Ceilings

Cloud acoustical ceilings are not attached to the structure except for the suspension wires and seismic braces. When these ceilings are viewed from below, they look much the same way as a cloud floating in the sky. The components used to construct clouds are many of the same components used for 15/16" exposed grid systems. Since clouds are not attached on the sides, this presents challenges to the installer and solutions to these challenges are discussed in this chapter.

### Shapes and Sizes

Kit cloud systems come in a variety of shapes and sizes. The most common kit cloud shapes are circular, oval, rounded square, square and rectangle. The largest circular cloud available has a 14' diameter and the smallest is 6' in diameter. Oval clouds measure 6' in one direction and either 8', 10', 12' or 14' in the other direction. Rounded square clouds measure 8' or 10' in one direction and either 8', 10', 12' or 14'

in the other direction. Square and rectangular clouds measure 6', 8', 10' or 12' in one direction and 6', 8', 10', 12' or 14' in the other direction.

In addition, there are other sizes available depending on the ceiling tile application. Staggered ceiling tiles, where the short end of the tile aligns in the middle of the long side of the adjoining tile, can be ordered in any 2' increment starting at 6' ending in 16' in either direction. The same is true for cloud ceilings called plank systems. Plank systems use a 2' wide ceiling tile in either 4', 6' or 8' length. As with any cloud, the size of the ceiling dictates the installation. The larger the ceiling, the more hanger wires and components will be required to complete the installation. Figure 1 shows different cloud ceiling configurations.

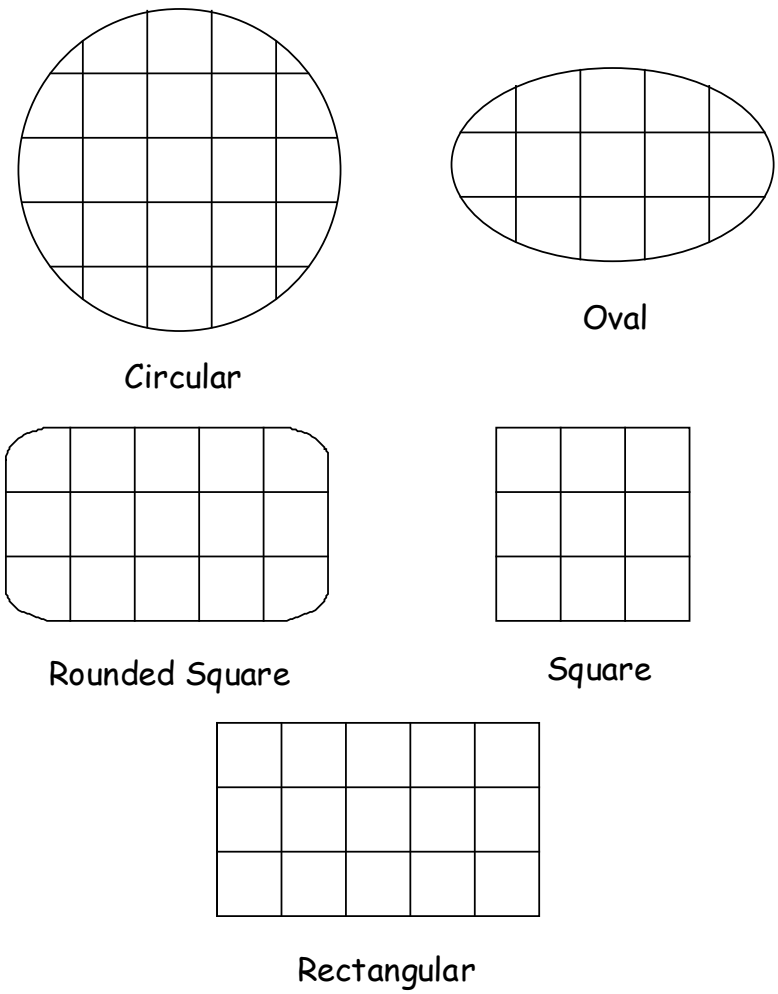

Figure 1 – Common Kit Cloud Shapes

## Components

The components used to fabricate cloud ceilings are many of the same components used for a 15/16" exposed grid system. Most manufacturers are supplying fabricated clouds in a kit, where the components are cut to length based on the size and configuration.

### Main Beam

The primary suspension member of the kit cloud ceiling system is the main beam. Main beams, also known as main runners, carrying tees, carrying runners or mains, have a web height of 1 11/16" and a prefinished 15/16" wide face flange. See Figure 2. Integrated clips, which interlock with other main beams, are attached to one end of the main beam when the size of the cloud exceeds 12'. The other end is square cut to accept a clip which locks into the perimeter trim. The reason one end of the main beam is square cut, or even both ends, is because the main beam is cut to length at the factory.

Most importantly, main beams have routs. A rout is a slot placed uniformly along the length of the main beam used to secure intermediate support members called cross tees. Rout locations start 3" from each uncut end of the main beam and every 6" afterwards. Rout locations can vary depending on the type of grid and manufacturer.

Heavy duty main beams are spaced 2' on center for kit cloud installations. This allows the hanger cables to be pulled 2' back from the cloud edges when a strong back is used in conjunction with the main beams. Although stick built clouds can have heavy duty main beams spaced at 4' on center without a strong back, the hanger cables or wires cannot be more than 10" away from the edges of the cloud. In seismic categories D, E and F, the hanger wires or cables cannot be placed more than 8" away from the edges of the cloud when the main beams are spaced 4' on center.

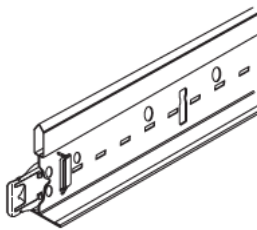
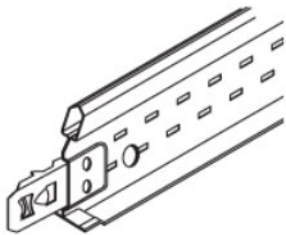

Figure 2 - Main Beam



## Cross Tees

Another suspension member of the cloud grid system is the cross tee, often called cross runners and cross T-bars. Cross-tees interlock with main beams at a 90° angle. An integrated clip is factory attached to each end and is inserted into the appropriate rout holes along the main beams. Cross tees for kit cloud ceilings come in 2' lengths and have a web height of 1 1/2" and a prefinished 15/16" wide face flange, see Figure 3. Some cross tees are cut to length at the factory, depending on the configuration and size of the cloud.



*Figure 3 - Cross Tee*

## Strong back

A strong back is a specially designed support member. Strong backs have notches punched along their length at 12" intervals. These notches are the same profile as the top bulb of a main beam. During installation, the strong backs are supported with the hanger cables and the main beams are inserted through the notches in the strong backs. See Figure 4. Strong backs run perpendicular to the direction of the main beams and parallel to the cross tees. Once the 2' cross tees are inserted, the strong backs are screw attached to the top bulb of the cross tees. The number of strong backs a cloud requires is dependent upon the size of the cloud. The strong backs are located 2' from the long sides of the cloud and 4' on center. In some instances, this pattern will result in two strong backs being positioned 2' from one another at the center of the cloud. Strong backs eliminate approximately 40% of the hanger cables or wires a stick cloud ceiling would require.

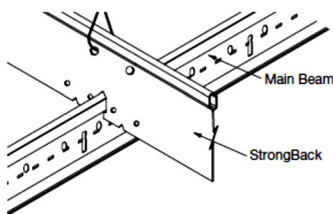

*Figure 4 - Strong back Connection to Main Beam*

## Aircraft Hanger Cable

Kit clouds are typically supported with aircraft cable. Aircraft cable is thinner and easily concealed from view. Each hanger cable has a factory installed loop on one end, which is cinched to mounting hardware appropriate for the surface to which it is attached. It is recommended the minimum support for each cable be capable of supporting 200 pounds. Some manufacturers supply a quick loop connector for the free end of the cable. The quick loop connector is inserted onto the aircraft cable and the end of the cable is placed through the hanger hole in the strong back and back through the quick loop connector. See Figure 5. Another option is to use 12 gauge hanger wires with the appropriate fastener based on the type structure where the attachment is made. A three-wrap tie is required at the connection to the main beam or strong back when using 12 gauge hanger wire.

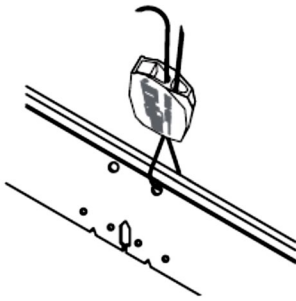

*Figure 5 - Hanger Cable with Quick Loop Connector*

## Perimeter Aluminum Trim

Perimeter trim is used to cap the edges of the cloud ceiling which defines the shape of the cloud. Typically made from extruded aluminum, it is available in different widths and heights and can be factory painted or anodized. Many profiles are available as shown in Figure 6. Some aluminum trims are rotated to accept different ceiling tile edge profiles, while others must be specifically ordered for the type of ceiling tile edge. See Figure 7.

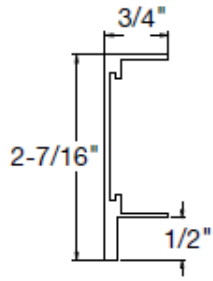

Figure 6 - Aluminum Trim Profiles

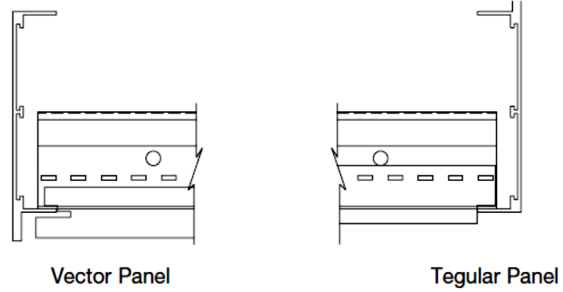

Figure 7 - Rotated Trim for Types of Tile

Each piece of aluminum trim is factory cut to length and mitered when necessary. Splice plates, as shown in Figure 8, secure each piece of trim to one another and at corners. Splice plates contain Allen screws which are tightened once the splice or corner joint is tight and acceptable. Care must be taken not to overtighten the Allen screws. Over tightening the Allen screws results in deformation of the exposed face. A connector clip, as shown in Figure 9, attaches to the ends of the main beams and cross tees to the aluminum trim. These clips are inserted in a continuous channel on the backside of the trim, called a boss, by slightly twisting the clip into the boss with a pair of pliers.

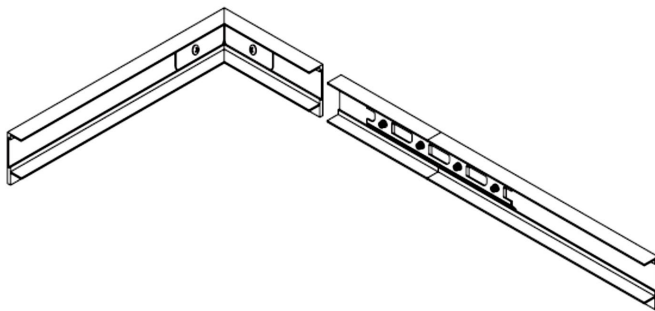

Figure 8 - Splice Plates

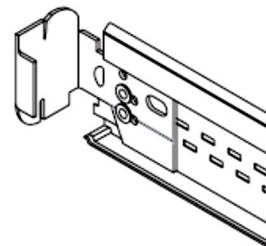

Figure 9 - Riveted Connector Clip

## Ceiling Tile

There are many options available to the architect when choosing the type of ceiling tile and the tile pattern. The tile pattern can be staggered or conventional as shown in Figure 10. In addition, the edge profile chosen for the ceiling tile could be flat lay-in, angled tegular, square tegular, beveled tegular or Vector as shown in Figure 11. The ceiling tile sizes ranges from 1' x 2', 2' x 2', 30" x 30", 2' x 4', 2' x 6' and 2' x 8'. Mineral fiber, metal, metal mesh and wood tile are possible. Most manufacturers

typically supply cloud kits in multiples of the tile size, therefore eliminating perimeter cutting of the ceiling tile.

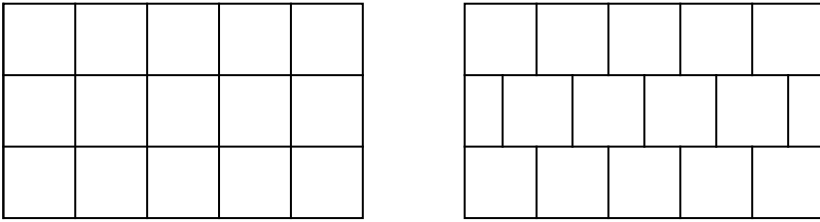

Figure 10 - Conventional and Staggered Tile Patterns

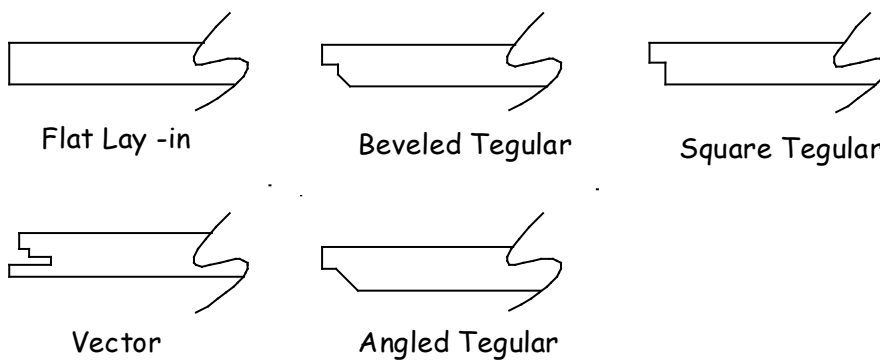

Figure 11 - Tile Edge Profiles

Some ceiling tile are directional, meaning a certain edge of the tile must face in the same direction. An arrow stamped on the back of the tile faces in the same direction for all directional tile being installed. Tegral tile and Vector tile require a precise scribe when they meet the aluminum trim. If tegular tile is used and cut to size, it requires a field cut tegular edge applied to the cut edge. Some manufacturers supply factory cut tile for circular and oval clouds.

It is important to install seismic hold down clips and spring border clips for Vector tile. These are a requirement in Seismic Design Category D, E and F which contains Northern California and for Vector tile installations in general.

### Kit Cloud Installation

Installation of the kit cloud begins with the layout of the outside edges and continues with locating the placement of the hanger cables. A review of the reflected ceiling plan will most likely have written dimensions from a perimeter wall or other feature to the edge of the cloud. In some instances, the architect will produce a symmetrical layout without giving dimensions and it is up to the installer to produce the layout. The mounting height of the cloud is usually given and is shown in Figure

12. Note how these gypsum board clouds are to be installed at an angle, with one end set to 19' - 0" and the other at 20' - 0".

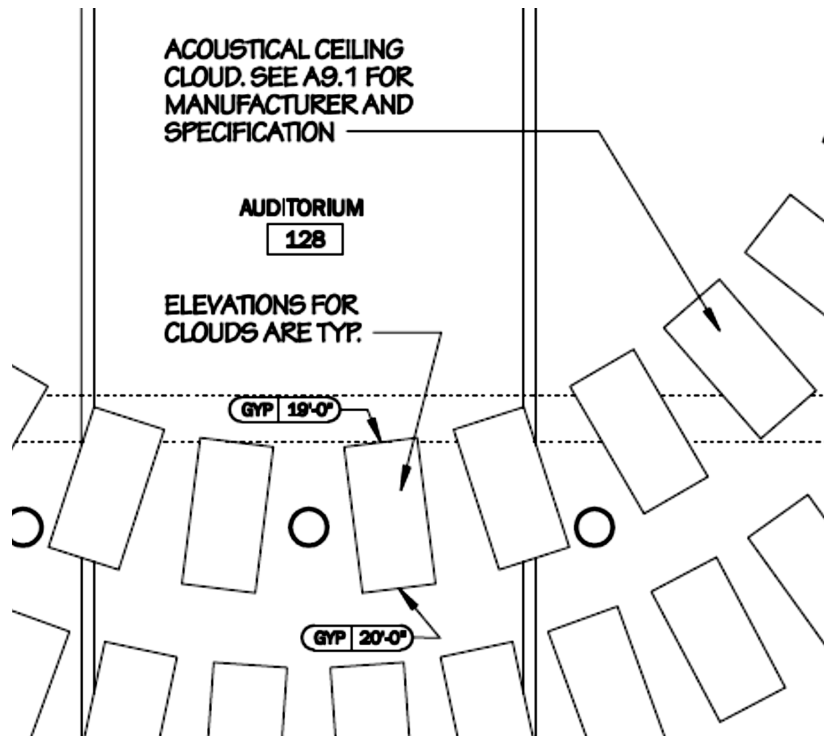

Figure 12 - Partial Reflected Ceiling Plan

## Layout

Begin the layout of the cloud by snapping lines representing the finished perimeter edges of the cloud. This would be the outside edge of the aluminum trim surrounding the cloud. Locate the long sides of the cloud and the strong backs. Strong backs run parallel to the long sides and are located 2' - 0" from the edge of the cloud and then 4' - 0" on center. Keep in mind the layout is from both long sides of the cloud. Sometimes this can result in two strong backs being 2' - 0" apart in the middle of the cloud. Never omit a strong back, as these cloud ceilings are engineered based on the load capacity of each hanger cable supporting the strong back. If the manufacturer has submitted a specific ceiling plan for locating the strong backs, this plan must be followed.

Hanger cables are located along each strong back, starting 1' - 0" from the ends of the strong back and then 4' - 0" on center along the length. Strong backs are installed perpendicular to the main beams and cut 1' - 0" less on each end than the length of the cloud. This places the first hanger cable 2' - 0" in from the ends of the cloud. Continue the layout of all strong backs and hanger cables until completion.

Measuring from each end of the strong back towards the center may result in the middle hanger cables being closer than 4' - 0" on center. Figure 13 shows a completed layout of a cloud ceiling.

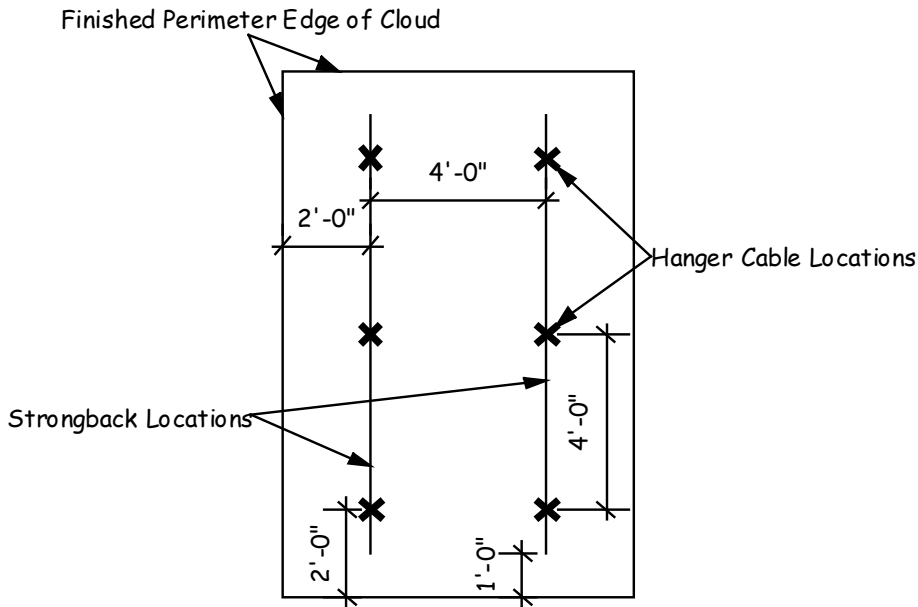

Figure 13 - Cloud Layout

### Procedure – Layout of a Kit Cloud Ceiling

1. Gather the information necessary from the reflected ceiling plan to locate the cloud ceiling.
2. Refer to the drawings supplied by the manufacturer for strong back locations and grid pattern.
3. Snap the lines representing the finished perimeter edges of the cloud.
4. Locate the longest side of the cloud.
5. Measure and mark 2' – 0" from each end of the cloud in the long direction.
6. Snap a line through the marks made in step 5.
7. Repeat steps 4 – 6 for the other side of the cloud.
8. Measure over 4' – 0" from the lines snapped in steps 6 & 7 and make additional strong back marks, if necessary.
9. Snap a line through the marks made in step 8.
10. Repeat steps 8 & 9 until all strong backs have been located.
11. Measure in 2' – 0" from the perimeter of the cloud along the short side and make a mark on all strong back locations.
12. Repeat step 11 for the opposing ends of the strong backs.

13. Measure and mark 4' – 0" on center from each end of all strong backs, locating all hanger cable locations.

### **Hanger Cable Installation**

The marks produced for each hanger cable during the layout process are transferred to the structure above by the use of a plumb laser. It is best to maintain each hanger cable in a plumb position, however never exceed the 6:1 ratio, unless another counter acting cable is installed. In some instances, it may be necessary to install a trapeze frame to support the hanger cable in the required position around large duct work and other features.

The anchor for attaching the cable to the building structure is supplied by subcontractor doing the work. Depending upon the situation, this could be a threaded expansion anchor, screw or a powder actuated fastener depending upon the composition of the building structure. Always follow the instructions supplied by the anchor manufacturer for installation. The hanger cables supplied in a kit have a loop attached to one end. It is acceptable to connect the hanger cable to the structure as shown in Figure 14 when possible.

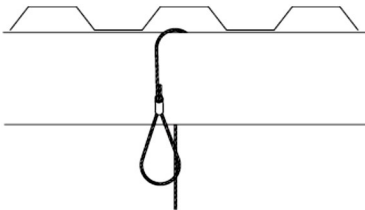

*Figure 14 - Optional Hanger Cable Connection*

### **Installation of Strong backs**

Unlike conventional acoustical ceilings, the grid for kit cloud ceilings begin with the installation of the strong backs. In addition, cloud ceilings can be fabricated at floor level, then raised into position and set at the proper elevation with a laser as reference. This is accomplished by the use of the specially designed connectors called quick loop connectors. These connectors provide a secure connection and act as pulleys when the ceiling is raised.

The installation of the strong backs begins with installing the quick loop connectors onto each hanger cable. See Figure 15. It is important to set the bottom of the quick connectors in the same elevation on all hanger cables. This is easily accomplished using a laser to locate the bottom of each quick connector. When the bottoms of the connectors are at the same elevation, the strong backs will be level with one another when they are installed. When cinching the loop tight through the quick connector and to the top of the strong back, the connector must be held in place

when tightening the loop. They have a tendency to ride up the cable unless held in place. Once the strong backs are checked for level, the main beams are installed in the proper notches along the bottom of each strong back.

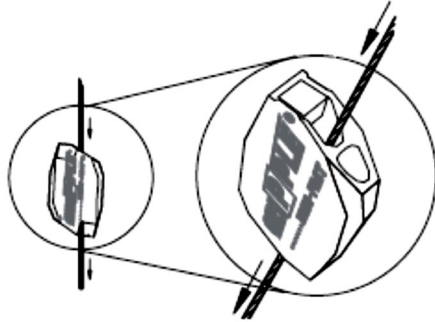

*Figure 15 - Installation of Quick Loop Connector*

### **Procedure – Installation of Hanger Cables and Strong backs**

1. Locate each hanger cable on the structure above referencing the floor layout.
2. Mark the position of each hanger cable using a plumb laser.
3. Install the appropriate attachment anchor at each location following the anchor manufacturer's instructions.
4. Install a hanger cable at each location using the looped end of the cable.
5. Set the laser to a safe and comfortable working elevation.
6. Thread the hanger cable through the proper side of each quick loop connector, stopping when the bottom of connector is in alignment with the laser.
7. Repeat step 6 for all quick loop connectors.
8. Locate and mark the required strong back hanger hole by placing the strong back on the floor layout and transferring the hanger cable layout.
9. Install the strong backs by threading the cable through the proper hanger hole and into the open side of the quick loop connector at each connector location.
10. Cinch the cable tight to the top of the strong back, while holding the quick loop connector in place.

### **Installation of Main Beams**

The main beams supplied by the manufacturer are cut to length and labeled at the factory for position. As mentioned before, when the size of the cloud exceeds 12', there will be staked on clip for connecting the main beams together on one end. The manufacturer supplies a cut list showing lengths and quantity of the main beams for the cloud. Additionally, the factory supplied ceiling plan shows the proper location of each cut main beam.



Insert the top bulb of each main beam into the proper notch along the bottom of the strong backs and make any staked on clip connections if necessary. See Figure 16. The first main beam will be placed 1' - 0" from the end of the strong back and the remainder will be placed at 2' - 0" centers. This is different from a conventional acoustical ceiling. The manufacturer will offset the splices in the main beams, so it is important to follow the ceiling plan when locating the main beams. Once the main beams are slid into place, visually check the main beams to confirm the ceiling is symmetrical. This means the rout holes will be in somewhat of alignment, and the ends of the main beams roughly follow the shape of the cloud.

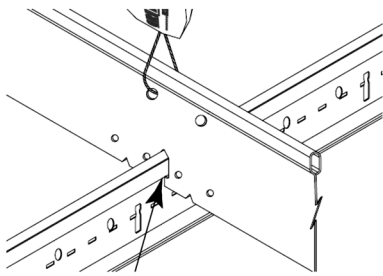

*Figure 16 - Installation of Main Beam*

### **Installation of Cross Tees**

The kit will contain the required number of 2' - 0" cross tees. When the cloud is oval or circular, some of the cross tees will be factory cut. Refer to the ceiling plan to properly locate these cross tees. Before installing the full cross tees, check the factory ceiling plan to confirm the grid pattern. In some instances, the tile pattern could be staggered, therefore the cross tees will not be placed in-line with one another. Staggered tile patterns require the installation of a Single Tee Adapter Clip - STAC clip to be code compliant. When a cross tee is not locked into a main beam with another in-line cross tee, a STAC clip is inserted and riveted as shown in Figure 17.

Locate the center of each main beam by placing a wedge clamp in the center of the middle tile or along the edge of the two middle tiles depending upon the size of the cloud. These clamps will serve as reference points during the cross tee installation and help locate the correct rout holes. The installation of the cross tees begins from the center of the cloud out towards the perimeters. See Figure 18. The clamps are also used to locate and keep the strong backs on the proper side of the rout holes or cross tee run, because the strong backs are attached to the cross tees. If the strong back ends up on the wrong side of the cross tee run, the cross tees will need to be removed and the strong back relocated. Locating the middle is especially helpful

when installing the cross tees for oval and circular cloud shapes. Keep in mind these ceilings are not attached to the walls and they do move during installation.

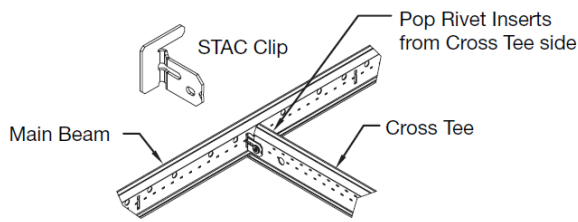

*Figure 17 - STAC Clip Placement and Attachment*

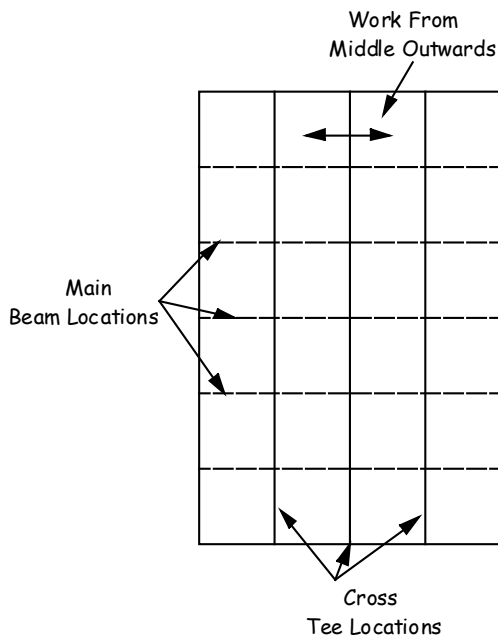

*Figure 18 - Direction of Cross Tee Installation*

Install all full cross tees between the main beams and when complete, slide the strong backs over along the top of the main beams until they come in contact with the cross tee runs. Clamp and screw each strong back to the top bulb of the cross tees. Use a #8 x 9/16" sharp point screw placed in the holes punched along the bottom of the strong back as shown in Figure 19. For the remaining cross tees, not supported on both ends by a main beam, bend the small tab at the end of the strong back as shown in Figure 20. Snap in cross tee and fit the bent tab under the top bulb of the cross tee as shown and insert a #8 x 9/16" sharp point screw. This tab is designed to set the cross tee to the proper elevation. Never use self-tapping screws for these connections. The gauge of the cross tee metal does not provide the proper pull-out

strength for the screw. The next step in the kit cloud installation is to position and attach the aluminum trim to the grid system.

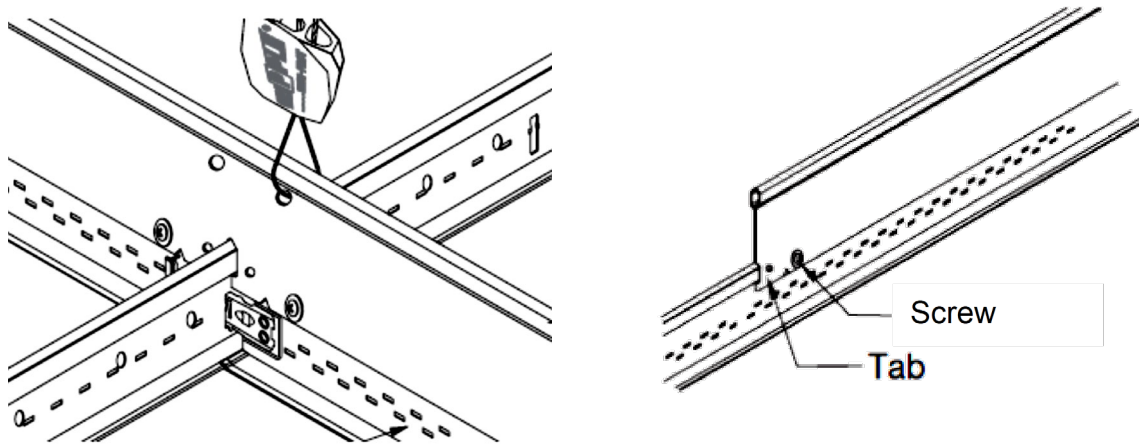

*Figure 19 - Strong back Connection to Cross Tees*      *Figure 20 – Setting Cross Tee Elevation*

### **Procedure – Installation of the Main Beams and Cross Tees**

1. Confirm the cut main beam locations using the factory supplied ceiling plan.
2. Starting 1' – 0" from the end of the strong backs, insert the top bulb of the first main beam(s) through the notch of each strong back.
3. Confirm the adjacent main beam(s) location and cut size.
4. Insert the top bulb of the main beam(s) through the notch of the strong back located 2' – 0" from the main beam(s) installed in step 3.
5. Complete the installation of the all main beams, repeating steps 4 & 5.
6. Visually confirm the rout holes and symmetry of the main beams, adjust if necessary.
7. Place a wedge clamp in the middle of all main beams.
8. Confirm the strong backs are on the same side of the cross tree runs.
9. Locate the correct rout holes and install the cross tees according to the ceiling plan.
10. Slide the strong back along the top of the main beams until contact is made with the cross tees.
11. Bend the small tab on the ends of the strong backs.
12. Snap end of unsupported cross tee into rout.
13. Place the cut or unsupported end of the perimeter cross tee on the bent tab.
14. Clamp the cross tee to the strong back and insert one #8 x 9/16" sharp point screw.
15. Repeat steps 12 & 13 for the remaining perimeter cross tees.

16. Clamp and attach one #8 x 9/16" sharp point screw to the bulb of all cross tees through the strong back on each side of the main beams.

### **Installation of Aluminum Trim**

The aluminum trim is provided with plastic protection when the kit is opened. Remove the plastic protection and set the trim aside. A template is provided by the manufacturer for the purpose of identifying the each cut piece of trim, but more importantly, the template locates where the main beams and cross tees attach to the each piece of trim for round and oval clouds. Place each piece of aluminum trim on the template and mark on the trim both sides of the intersecting main beam or cross tee. These marks are the starting point for squaring the grid and for locating the main beam and cross tee connector clips. For square and rectangular clouds, the intersection of the main beams and cross tees are not marked and will need to be located by measuring from the mitered end of the aluminum trim. The aluminum trim is attached to the grid using connector clips.

The connector clips should be riveted or screwed onto the ends of the perimeter cross tees and the ends of the main beams which will be used to initially engage the aluminum trim. See Figure 21. Two #8 screws are preferred for all other connector clips, because these clips can be adjusted if necessary.

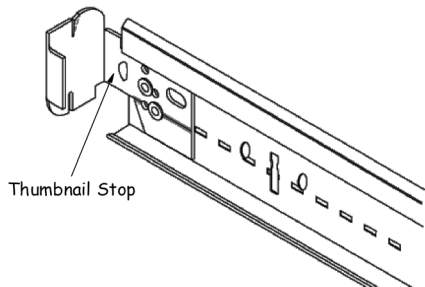
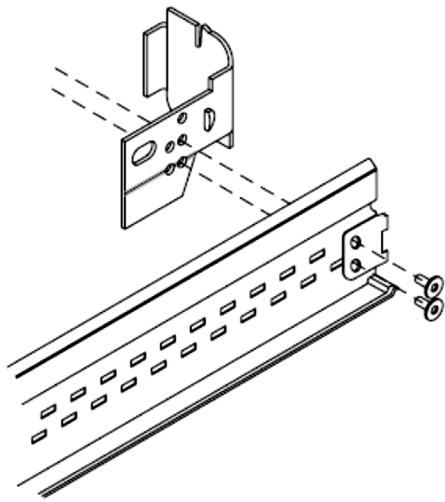

*Figure 21 - Connector Clip Attachment to Main Beam*

A drawback when using screws is the screws may interfere with the installation of the ceiling panels. Eventually, all cross tees and main beams will have a connector clip attached. The grid is squared before permanently attaching all of the connector clips to the grid members. When installing the connector clips, the top of the clip must touch the bottom of the main beam top bulb and the end of the main beam must contact the thumbnail stop on the connector clip.

When attaching the connector clips to the cross tees, a portion of the staked on clip is cut away. The connector clip has a series of three holes in alignment. The bottom

two holes are aligned with the two holes of the staked on clip and the clip is either riveted or screw attached as shown in Figure 22.



*Figure 22 - Connector Clip Attachment to Cross Tee*

Reference the manufacturers ceiling plan to arrange the cut aluminum trim sections in the proper sequence. For square and rectangular kit clouds with full tiles, mark the centerline of the main beams or cross tees on the inside of the trim. The first cross tee or main beam should be located  $24 \frac{5}{16}$ " from the mitered end of the trim and then 24" on center for the remaining cross tees or main beams. Using two people, raise the trim into position and slightly twist two cross tees or main beams with the connector clip attached and engage the clip into the boss of the trim at the centerline marks. See Figure 23. Hold the tab on the clip with a pair of pliers and lock it into position by twisting the clip clockwise. The remaining connector clips are left unattached from the grid members, but are twisted into place at the 24" on center marks. Clamp the grid members to the connector clips and double check the grid members are aligned to the center line marks.

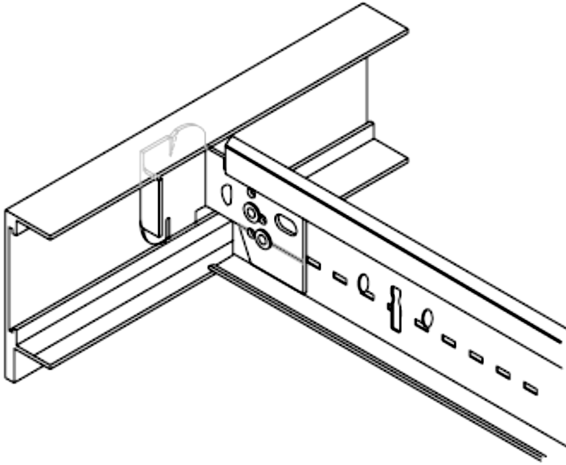

*Figure 23 - Connector Clip Engaged Into Boss*

The aluminum trim sections are connected together with splice plates and are installed into the boss of the trim. See Figure 24. Complete installing the aluminum trim by twisting only two cross tees or main beams into place per piece of trim. The remaining clips and grid members are only clamped into place until the cloud is squared. Depending upon the height of the trim, two splice plates may be required at each connection. The splice plates are used for both straight connections and for the 90° corners. For 90° corners, the splice plate is easily bent by hand to a 90° angle. The splices are secured with Allen screws built into the splice plate. Overtightening the Allen screws results in deformation of the trim and will show on the finished surface. The following procedure explains the trim installation and squaring of the grid follows in the next section.

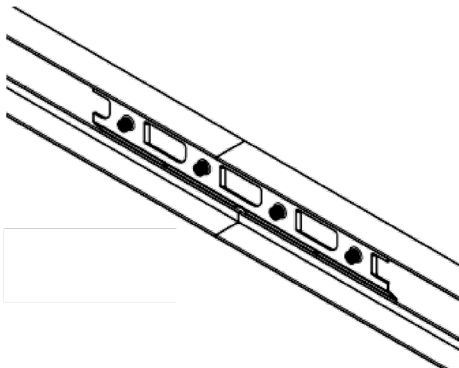

*Figure 24 - Installed Splice Plate*

## **Procedure – Installation of Aluminum Trim**

1. Remove the aluminum trim from the plastic protection.
2. Reference the factory ceiling plan and locate each piece of trim for installation.
3. Measure and mark from the mitered end of the aluminum trim, 24 5/16" for the center of the first cross tee or main beam location.
4. Butt the remaining trim together on that particular side and continue marking the trim with a 24" on center layout.
5. Repeat steps 3 & 4 for the trim on the three remaining sides.
6. Slide the splice plates into the channel boss of the trim, leaving the Allen screws unattached.
7. Bend four splice plates to a 90° angle and insert these into one end of the mitered trim, leaving the Allen screws unattached.
8. Permanently attach two connector clips to cross tees or main beams for each piece of trim.
9. Raise the piece of trim into place, twisting the two connector clips on layout into the channel boss of the trim using pliers.
10. Double check the center line mark on the trim is in the center of the cross tees or main beams, adjust if necessary.
11. Repeat steps 8 – 10 for the remaining pieces of trim, while engaging the splice plates between each piece and at the corners.
12. Tighten the Allen screws on each side of the splice connection.
13. Twist the remaining connector clips on layout into the channel boss of the trim using pliers.
14. Clamp the unattached cross tees or main beams to the connector clip around the perimeter of the cloud.
15. Double check that the center line marks on the trim is in the center of the cross tees or main beams, adjust if necessary.

## **Squaring the Cloud**

Squaring a cloud is as much about measuring as it is about visually confirming the alignment of the main beam runs, cross tee runs and the aluminum trim. The grid for a cloud is checked for square in the same way as a conventional acoustical ceiling. Before diagonally measuring and installing dry lines, visually check the ends of each cross tee run and main beam where they attach to the trim to make sure they are straight. Adjust the cross tees or main beams, if necessary, by tapping on the clip with a screwdriver and hammer.

Install two dry lines, one next to a cross tee run and one along the side of a main beam run, close to the middle of the grid. The dry lines should not be placed from

trim to trim, but on the grid one tile bay inside of the trim. Sight down the dry lines and confirm the cross tee run and main beam run are straight. This is why the connector clips were not permanently attached during the trim installation. If the cross tee runs or main beam runs are not straight, the grid members can be lightly tapped into alignment. Place a screwdriver into a hanger hole and tap with a hammer until the run is in alignment with the dry lines. See Figure 25 for dry line placement.

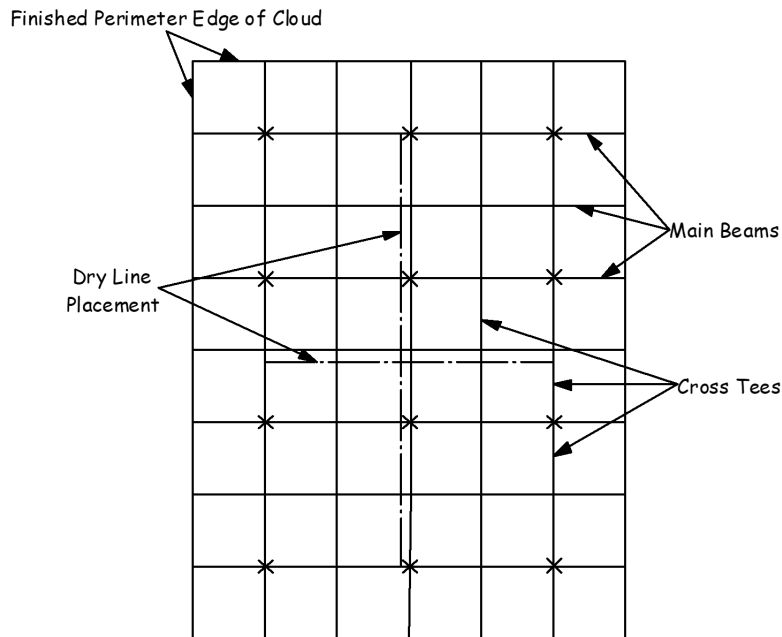

*Figure 25 - Placement of Dry Lines*

Diagonal measurements are taken from one or more grid bays, the larger the measurement or more grid bays the better. See Figure 26. If the diagonal measurements are the same, the grid is square. In some situations, it may be beneficial to install a diagonal brace, made from a main beam, on top of the grid. Attach one end to a main beam web and clamp the opposite end to the web of another main beam. Adjust the diagonal brace until the grid measures square, and permanently attach the main beam. This will keep the grid square. Installing a few tiles in the center bays of the grid can help to maintain square as well. Once the grid has measured square and the cross tee runs and trim are visually straight, permanently attach the connector clips to the main beams and cross tees.



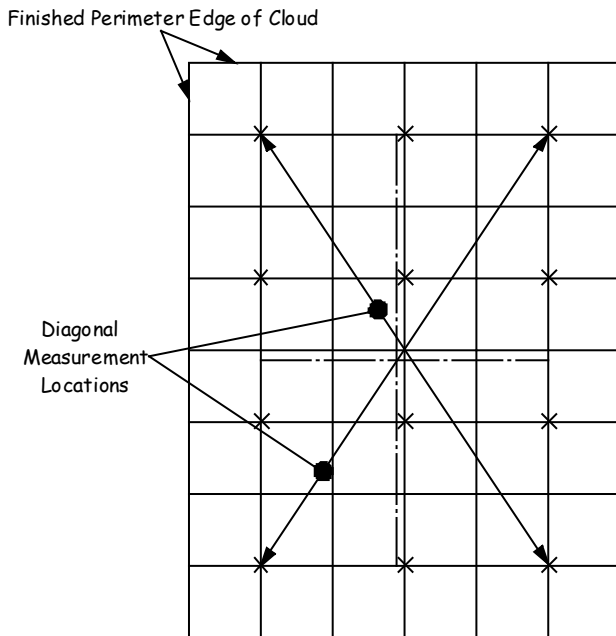

*Figure 26 - Diagonal Measurement Locations*

Because cloud ceilings are free floating, keeping the ceiling square is a challenge. Making slight adjustments in one direction can move the ceiling out of adjustment in another direction. This is why using dry lines is important. Dry lines show how slight adjustments affect the installation and where the installer may need to compensate for the adjustments.

### **Procedure – Squaring the Cloud**

1. Visually check the alignment of the main beam runs, cross tee runs and the perimeter trim.
2. Adjust the grid members into alignment by slightly tapping the connector clips with a screwdriver and hammer, if necessary.
3. Loosen the clamp on the connector clips to adjust the perimeter trim in and out and re-clamp if necessary.
4. Install two dry lines, one grid bay away from the trim in both directions.
5. Check the alignment of the grid members to the dry lines.
6. Adjust the grid members to align with the dry lines by unclamping the connector clips and re-clamp after alignment, if necessary.
7. Check the grid for square by measuring diagonally.
8. Install one or more diagonal brace(s) to maintain square, if necessary.
9. Confirm the grid is square and the alignment of the cross tees and main beams is acceptable.

10. Attach the connector clips to the grid members along the perimeter of the cloud using two screws or rivets per connection.

### **Setting the Cloud to Elevation**

If the cloud was assembled at the elevation shown the reflected ceiling plan, the next step is to install seismic bracing and the ceiling tile. However, clouds can be assembled at floor height and raised into position when quick loop connectors are used. The ceiling tile should be installed once the grid work has been raised and set to the proper elevation. This eliminates most of the weight when the raising the cloud ceiling.

A mark is made on each cable at the final installation height, plus the dimension from the bottom of the cloud to the top of the strong backs. For example, if the cloud ceiling measures 3 3/8" to the top of the strong back and the architect has specified the installation height at 12' – 0", the bottom of the quick loop connectors or the top of the strong back would be 12' – 3 3/8" from the finished floor . Mark each cable at this elevation during assembly or before raising the cloud ceiling. If the quick loop connectors move out of position they can be reset to the mark and therefore the correct elevation when the cloud is raised. In addition, the mark on the cable would align with the top of the strong back when larger loops are made at the quick loop connection.

Set a laser to a known dimension below the cloud ceiling. Raise the cloud by sliding the quick loop connector up the cable and removing the slack in the cable by pulling on the cable. Only pull on two cables at a time approximately 24" or less and work symmetrically around the cloud. Raising a cloud into position is best using two or more installers. This prevents the cloud from becoming stressed or twisted when it is being raised. Reference the laser as the cloud ceiling nears the installation elevation. Slowly pull the cable until contact is made with the quick connectors set at the calculated elevation mark or the top of the strong back aligns with the mark. Double check the installation height of the cloud by referencing the laser. When the architect stipulates a slanted ceiling, make the necessary calculations when marking the hanger cables.

### **Installation of Seismic Bracing**

Seismic bracing will be required in Northern California for all cloud ceilings. The architect should provide a detail of the brace. Reference the drawings to confirm the brace locations. If the locations are not shown or a construction detail is not given, a request for information – RFI should be issued. All seismic bracing must be approved by the architect and reviewed by the local building department.

## Installation of Ceiling Tile

The ceiling tile is installed after all inspections have been completed; this includes the cloud grid system, electrical and fire sprinklers. Any excess length of hanger cable should be wound up and taped in a small coil. This prevents the cable from being in the way of the tile installation, but also allows the cloud ceiling to be set at a lower elevation if desired. Cut tegular tile requires a field applied tegular edge be scribed on the cut edge or edges. When the edges of the tegular or Vector tile remains exposed, these edges will require a coat of factory supplied paint. In some situations, the manufacturer will supply the tile pre-cut to the shape of the cloud. This is especially true when an emblem or other graphic, supplied by Armstrong®, has been applied to the tile as shown in Figure 27.



*Figure 27 - UBC Emblem*

Seismic hold down clips and spring border clips are required for Vector ceiling tiles. Hold down clips install over the top of the main runner or cross tee bulb with a spring action applying pressure to the ceiling tile. Hold down clips have two metal wings, which lock under the bulb securing both the tile and clip in place. Hold down and spring border clips are installed during the installation phase of the ceiling tile. It is important to note, only the recessed “A” and “B” edges have the hold down clip applied, see Figure 28.

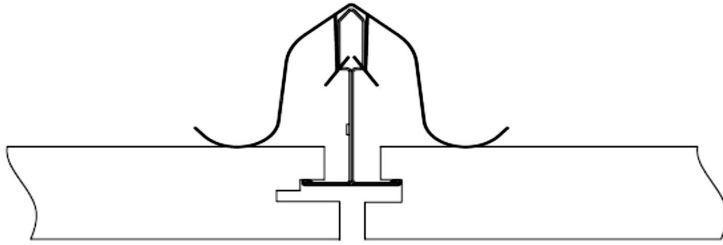

*Figure 28 - Installed Hold Down Clip*

Clipping the “A” edge automatically clips the “B” edge, as these edges are next to one another when the arrow defining the “A” edge points in the same direction. The “C” and “D” edges must remain unattached and have the ability to move within the grid system. Always follow any details or drawings for hold down and spring border clip placement.

### **Final Cleaning**

The aluminum trim is wiped down with a non-abrasive cleaner to remove any handprints or other smudges. A dry chemical cleaning sponge should be used to remove any smudges from the face of the ceiling tile and any chipped edges touched up or caulked. Test wipe a left over ceiling tile with the dry chemical sponge to make sure it is compatible with the surface of the tile.

Chapter 1  
Study Guide

**Directions:**

Answer the following questions using the bubble answer sheet.

1. The most common cloud shapes are circular, oval, rounded square, square and rectangle.
  - A. True
  - B. False
  
2. It is best to maintain each hanger cable in a plumb position, however never exceed the \_\_\_\_\_:1 ratio, unless another counter-acting cable is installed.
  - A. 2
  - B. 4
  - C. 6
  - D. 8
  
3. When installing cross tees, always work from the center of the cloud out towards the perimeters.
  - A. True
  - B. False
  
4. For square and rectangular clouds, the intersection of the main beams and cross tees on the aluminum trim are located by measuring from the \_\_\_\_\_ end of the aluminum trim.
  - A. square
  - B. angled
  - C. mitered
  - D. beveled
  
5. Dry lines show how slight \_\_\_\_\_ affect the installation and where the installer may need to compensate for the adjustment.
  - A. adjustments
  - B. movements
  - C. corrections
  - D. alignments

6. Seismic hold down clips and spring border clips are required for Vector ceiling tiles installed in seismic zones D, E, and F.
- A. True
  - B. False
7. A \_\_\_\_\_ ceiling tile layout is where the short end of the tile aligns in the middle of the long side of the adjoining tile.
- A. offset
  - B. uneven
  - C. staggered
  - D. aligned
8. Strong backs have notches punched along their length at \_\_\_\_\_" intervals and these notches are the same profile as the top bulb of the main beams.
- A. 6
  - B. 8
  - C. 10
  - D. 12
9. Connector clips secure each piece of trim to one another and at corners.
- A. True
  - B. False
10. Installation of cloud begins with the layout of the perimeter edges of the cloud and continues with locating the placement of the strong backs and hanger cables.
- A. True
  - B. False
11. Hanger cables are located along each strong back, starting \_\_\_\_\_' - 0" from the ends of the strong back and then \_\_\_\_\_' - 0" on center along the length.
- A. 1,3
  - B. 1,4
  - C. 2,3
  - D. 2,4
12. The grid work, not including hanger cables, for a cloud ceiling begins with the installation of the strong backs.
- A. True
  - B. False

13. The manufacturer supplies a \_\_\_\_\_ list showing lengths and quantity of the main beams for the cloud.
- A. cut
  - B. itemized
  - C. schedule
  - D. chart
14. The first main beam for kit cloud ceilings is placed 2' - 0" from the end of the strong back and the remainder are placed at 2' - 0" centers.
- A. True
  - B. False
15. The aluminum trim is attached to the grid using \_\_\_\_\_ clips.
- A. splice
  - B. loop
  - C. connector
  - D. angle
16. Overtightening the Allen screws of a splice plate results in deformation of the trim and will show on the finished surface.
- A. True
  - B. False
17. \_\_\_\_\_ a cloud is as much about measuring as it is about visually confirming the alignment of the main beam runs, cross tee runs and the aluminum trim.
- A. Completing
  - B. Leveling
  - C. Squaring
  - D. Installing
18. The ceiling tile should be installed once the grid work has been raised and set to the proper elevation.
- A. True
  - B. False
19. If the location of the seismic braces is not shown or a detail is not given, a request for information – RFI should be issued.
- A. True
  - B. False

20. Kit cloud ceiling tile is installed after all \_\_\_\_\_ have been completed.
- A. braces
  - B. inspections
  - C. cables
  - D. strong backs
21. It is important to note, only the recessed “C” and “D” edges of a Vector ceiling tile have a seismic hold down clip applied.
- A. True
  - B. False
22. Strong backs run perpendicular to the direction of the main beams and parallel to the cross tees.
- A. True
  - B. False
23. Never delete a strong back, as these cloud ceilings are engineered based on the load capacity of each hanger cable supporting the strong back.
- A. True
  - B. False
24. The factory supplied ceiling plan shows the proper location of each cut main beam.
- A. True
  - B. False
25. Eventually all cross tees and main beams will have a connector clip attached, but the grid is \_\_\_\_\_ before permanently attaching all of the connector clips to the grid members.
- A. aligned
  - B. clipped
  - C. squared
  - D. leveled
26. Connector clips are locked into position by twisting the clip counter-clockwise in the boss of the perimeter trim.
- A. True
  - B. False



27. The first cross tee or main beam should be located \_\_\_\_\_" from the mitered end of the trim and then 24" on center for the remaining cross tees or main beams.
- A. 22 1/2
  - B. 24
  - C. 24 5/16
  - D. 24 15/16
28. Dry lines used for squaring the cloud are installed next to a cross tee run and along the side of a main beam run close to the middle of the grid.
- A. True
  - B. False
29. Raising a cloud into position is best using \_\_\_\_\_ or more installers.
- A. two
  - B. three
  - C. four
  - D. six
30. Once the 2' cross tees are inserted, the \_\_\_\_\_ is screw attached to the top bulb of the cross tees.
- A. brace
  - B. strongback
  - C. cable
  - D. clip
31. Perimeter \_\_\_\_\_ is used to cap the sides of the cloud ceiling and provides the defining shape of the cloud.
- A. metal
  - B. aluminum
  - C. trim
  - D. angle
32. Instead of using 12 gauge hanger wire, kit clouds are typically supported with aircraft cable.
- A. True
  - B. False

33. Connector clips are inserted in a continuous channel on the backside of the trim called a \_\_\_\_\_.
- A. boss
  - B. groove
  - C. slot
  - D. opening
34. Strong backs are located \_\_\_' from the longest side of the cloud and \_\_\_' on center.
- A. 1,3
  - B. 1,4
  - C. 2,3
  - D. 2,4
35. If tegular tile is used and cut to size, it requires a field cut tegular edge applied to the cut edge.
- A. True
  - B. False

# Exercise #1

## Manufacturer Supplied Ceiling Plan

### Directions:

Use the factory ceiling plan supplied by the Armstrong® to answer the following questions about the cloud.

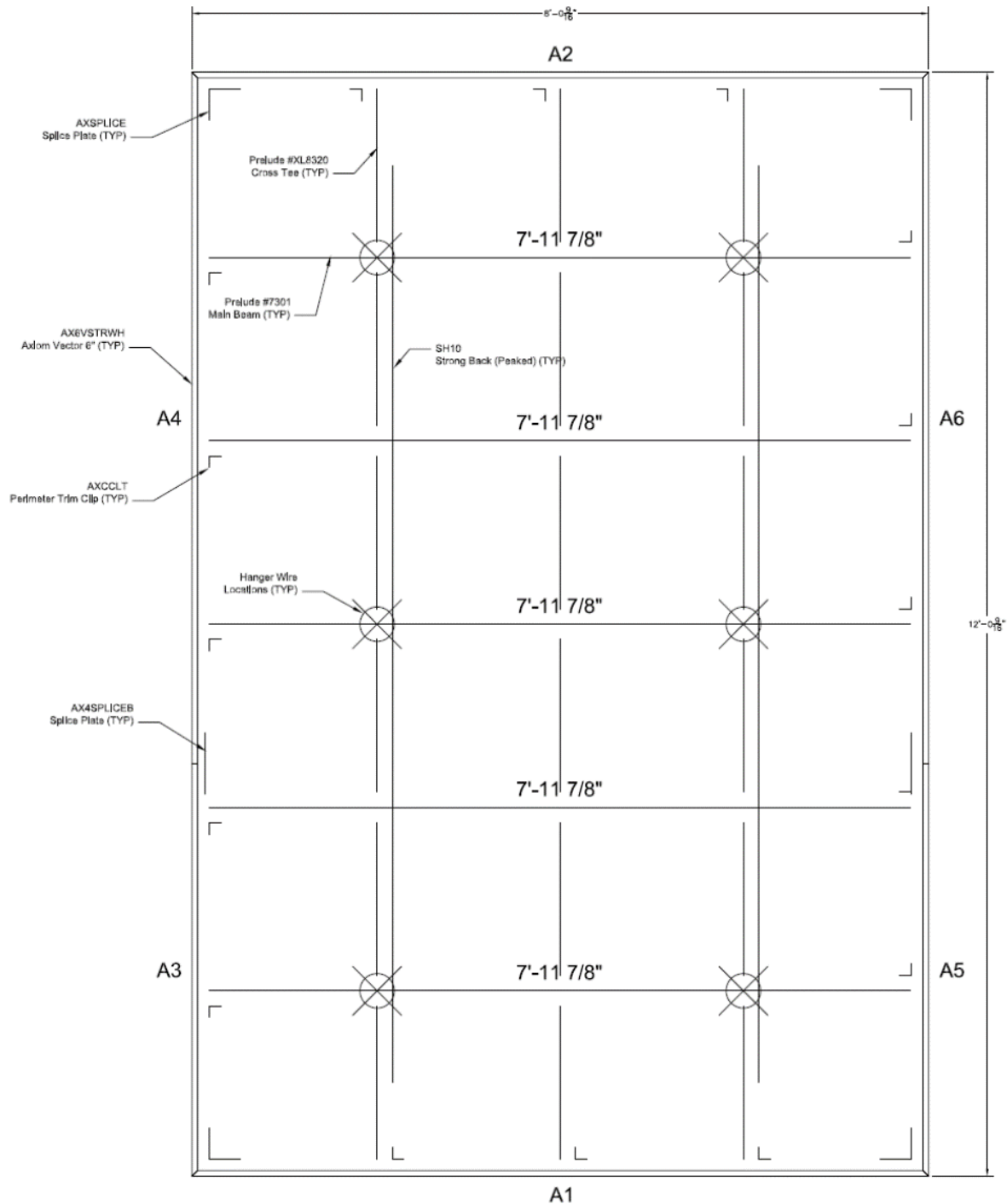

1. What are the overall dimensions of the cloud?
  - A.  $8' - 0 \frac{9}{16}'' \times 12' - 0 \frac{9}{16}''$
  - B.  $14' - 0 \frac{9}{16}'' \times 12' - 0 \frac{9}{16}''$
  - C.  $7' - 0 \frac{5}{16}'' \times 12' - 0 \frac{9}{16}''$
  - D.  $8' - 0'' \times 8' - 0''$
  
2. How many individual main beams are contained in the cloud?
  - A. 2
  - B. 3
  - C. 5
  - D. 6
  
3. How many cross tees are contained in the cloud?
  - A. 12
  - B. 16
  - C. 18
  - D. 28
  
4. How many strong backs are contained in the cloud?
  - A. 2
  - B. 3
  - C. 4
  - D. 5
  
5. How many splice plates are contained in the cloud?
  - A. 2
  - B. 3
  - C. 4
  - D. 6
  
6. How many hanger wires/cables are contained in the cloud?
  - A. 4
  - B. 6
  - C. 8
  - D. 9

7. How many full ceiling tiles are contained in the cloud?
- A. 18
  - B. 20
  - C. 24
  - D. 26
8. Are there any hanger wires/cables closer than 2' – 0" from the perimeter edges?
- A. Yes
  - B. No
9. Based on the size of this cloud, are there any strong backs less than 4' – 0" on center?
- A. Yes
  - B. No
10. What size is the longest factory cut main beam?
- A. 9' – 10 1/4"
  - B. 7' – 11 7/8"
  - C. 10' – 0"
  - D. 14' – 9/16"
11. How many connector clips are required to connect the cross tees to the perimeter trim?
- A. 4
  - B. 6
  - C. 10
  - D. 16
12. How many main beam and cross tee connections are there to the perimeter trim?
- A. 16
  - B. 18
  - C. 22
  - D. 24

## Manufacturer Supplied Ceiling Plan

### Directions:

Use the factory ceiling plan supplied by the Armstrong® to answer the following questions about the cloud.

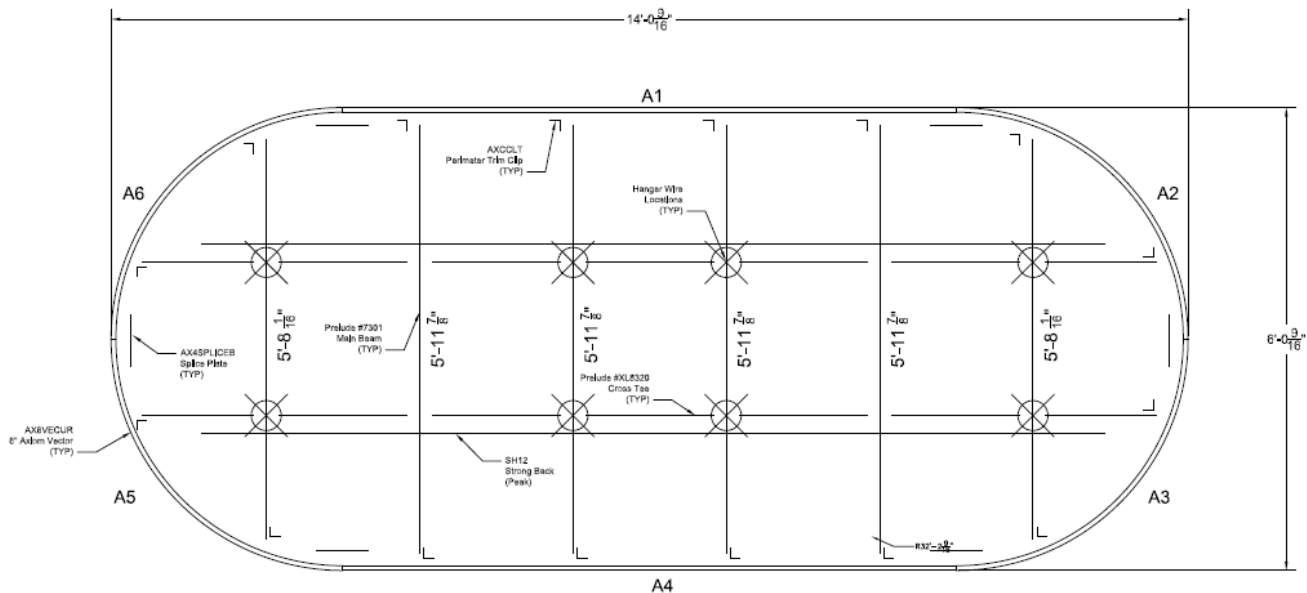

1. What are the overall dimensions of the cloud?
  - A. 8' – 0 9/16" x 12' – 0 9/16"
  - B. 6' – 0 9/16" x 14' – 0 9/16"
  - C. 7' – 0 5/16" x 12' – 0 9/16"
  - D. 8' – 0" x 8' – 0"
  
2. How many individual main beams are contained in the cloud?
  - A. 2
  - B. 3
  - C. 5
  - D. 6
  
3. How many cross tees are contained in the cloud?
  - A. 12
  - B. 14
  - C. 16
  - D. 20

4. How many strong backs are contained in the cloud?
  - A. 2
  - B. 3
  - C. 4
  - D. 5
  
5. How many splice plates are contained in the cloud?
  - A. 2
  - B. 3
  - C. 4
  - D. 6
  
6. How many hanger wires/cables are contained in the cloud?
  - A. 4
  - B. 6
  - C. 8
  - D. 9
  
7. How many full ceiling tiles are contained in the cloud?
  - A. 6
  - B. 9
  - C. 11
  - D. 26
  
8. Are there any hanger wires/cables closer than 2' – 0" from the perimeter edges?
  - A. Yes
  - B. No
  
9. Based on the size of this cloud, are there any strong backs less than 4' – 0" on center?
  - A. Yes
  - B. No
  
10. What size is the longest factory cut main beam?
  - A. 5' – 8 1/16"
  - B. 5' – 11 7/8"
  - C. 10' – 0"
  - D. 14' – 9/16"

11. How many connector clips are required to connect the cross tees to the perimeter trim?
- A. 4
  - B. 6
  - C. 10
  - D. 12
12. How many main beam and cross tee connections are there to the perimeter trim?
- A. 16
  - B. 18
  - C. 22
  - D. 24



## Chapter 2

### **Stick Framed Cloud Ceilings**

#### **Objectives:**

Upon completion of this chapter, students will be able to:

- 1) Explain the differences between stick framed and kit cloud ceilings.
- 2) Layout a stick framed cloud ceiling based on the project drawings.
- 3) Install a stick framed cloud grid system with ceiling tiles.

#### **Introduction**

This chapter introduces the stick framed cloud ceiling. Although kit clouds have proven to be up to 55% faster to install, many contractors supply standard length main beams, cross tees and aluminum perimeter trim pieces. These components require field cutting to match the size of the cloud as specified in the construction drawings. There are many ways to install a stick framed cloud ceiling depending upon its size and shape.

The following information and procedures address two methods of installation. The first method is to install, brace, and square a grid to a size larger than the overall dimensions of the finished cloud. The perimeter trim is assembled to the finished size on top of the grid and the grid is marked, cut and fit to the perimeter trim. This method is most often used for circular, oval and irregular shaped clouds. The other method is to calculate the size of the grid components and cut the main beams and cross tees to length before installation. This method replicates a kit cloud and saves time in the field when the shape of the cloud ceiling is rectangular or square.

The major components for stick framed cloud ceilings are the same as kit clouds and will not be repeated in this chapter; however the minor differences will be illustrated and noted. For the purposes of this discussion, 15/16" heavy duty exposed grid material is used.

#### **Stick Framed Installation – Cut-in Method**

Installation begins with finding the cloud dimensions and location of the cloud. The finished perimeter edges of the cloud or the radius point or points are located and are marked on the floor. In addition, the reflected ceiling plan is referenced to confirm the grid pattern, and grid type.

## Layout

With the perimeter edges, radius points or center point of the cloud ceiling established, the next step is to locate the main beams and cross tees. Heavy duty main beams for a stick framed ceiling are spaced 4' – 0" on center and the cross tee placement depends on the grid pattern. A typical 2' x 4' grid pattern has 4' cross tees at 2' on center. The same applies to a 2' x 2' grid pattern, with 2' cross tees installed between the 4' cross tees to provide the 2' x 2' grid pattern. With the main beams and cross tee layout completed, the hanger wire layout is marked. See Figure 29 for a 2' x 2' grid pattern layout, locating the main beams and cross tees.

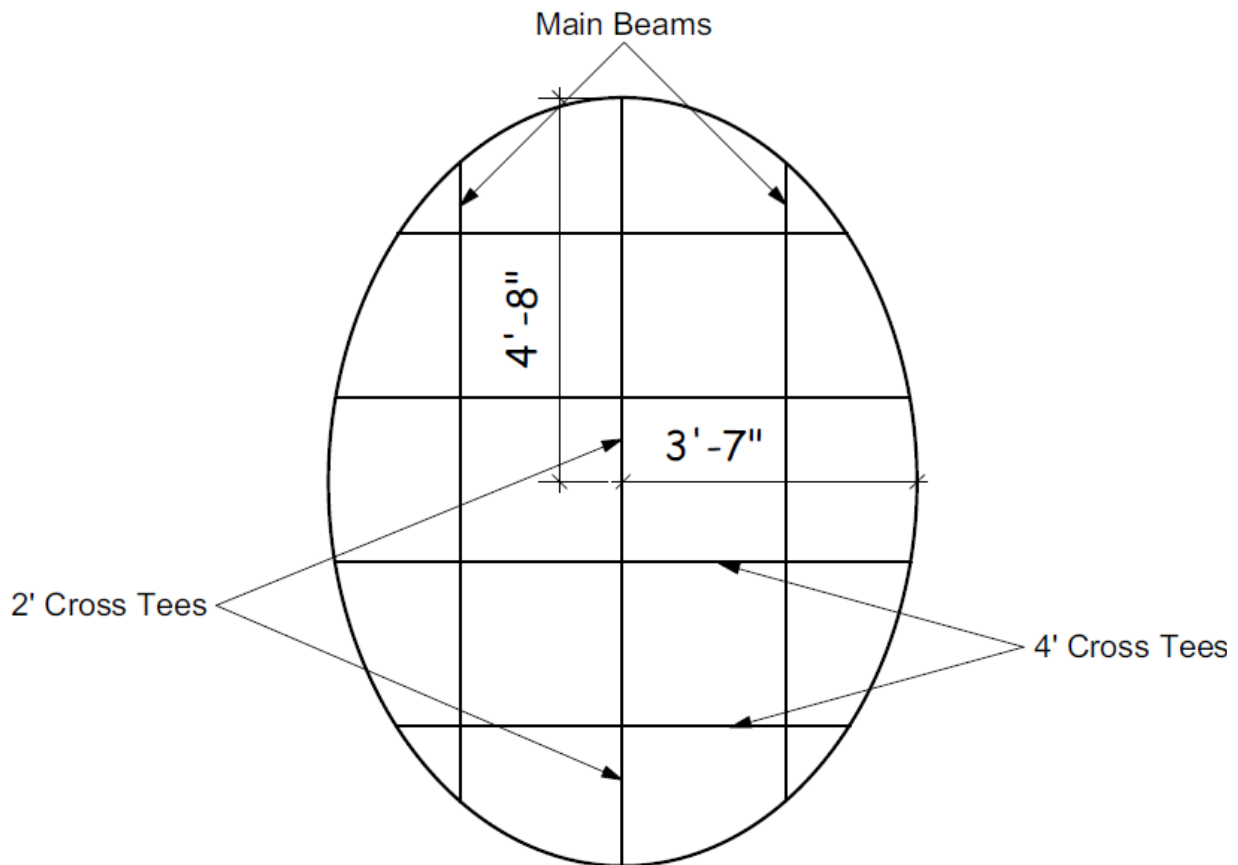

*Figure 29 - 2' x 2' Grid Pattern*

### **Procedure – Layout of a Stick Framed Cloud Ceiling**

1. Gather the information necessary from the reflected ceiling plan to locate the cloud ceiling.
2. Determine the grid pattern, main beam and cross tee layout.
3. Snap the lines representing the finished perimeter edges or mark the radius points of the cloud.

4. Snap lines representing the main beams and cross tees.

### **Hanger Wire Installation**

Northern California requires each main beam to have a hanger wire within 8" of the cut ends and hanger wires spaced 4' – 0" on center from the ends. In some instances, for a symmetrical wire layout, hanger wires for main beams can be spaced less than 4' – 0" on center, but never greater than 4' – 0" on center. Cross tees over 8" in length require a hanger wire placed within 8" of the cut ends as well. Aluminum perimeter trims 10", 12", 14" and 16" in height must be supported directly from the structure with two hanger wires per piece of trim as shown in Figure 30. Cross tees located on each side of a splice joint require a hanger wire regardless of their length.

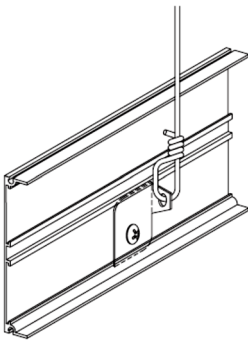

*Figure 30 - Supported Perimeter Trim*

An example of a hanger wire layout is shown in Figure 31, based on the grid pattern shown in Figure 29, not including wires for the trim. These wires are best installed after the perimeter trim installation. A hanger wire layout is performed on the floor below the cloud ceiling after the main beams and cross tees have been located. The wire layout is plumbed to the structure above using a laser, so the hanger wires hang plumb in the correct location.

This allows the installation to proceed smoothly and prevents any unnecessary wires from being installed beyond the edges of the cloud. Always follow the detailed drawings made by design professionals based on the actual weight of the cloud ceiling, when alternate materials other than typical ceiling tiles, are used. Hanger wires should extend a minimum of 12" past the horizontal installation height of the cloud ceiling for a proper three wrap tie.

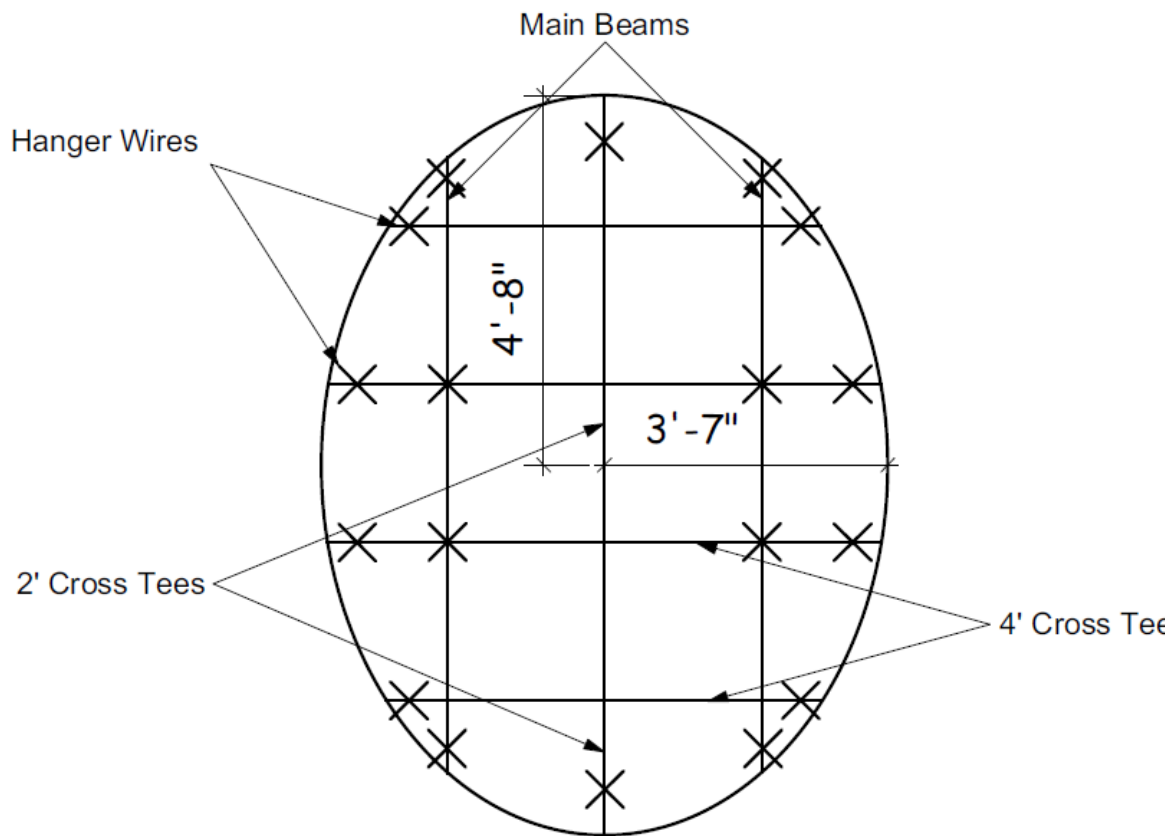

Figure 31 - Hanger Wire Layout

### Procedure – Installation of Hanger Wires

1. Mark the hanger wire locations on the floor layout, within 8" of the free ends for cross tees and main beams and 4' on center or less for main beams.
2. Locate each hanger wire on the structure above referencing the floor layout.
3. Install the appropriate attachment anchor and hanger wire at each location following the anchor manufacturer's instructions.

### Main Beam and Cross Tee Installation

Set the laser to an elevation below the finished height of the ceiling where a laser card will be of value when checking level. Bend the main beam hanger wires at the required elevation by referencing the laser using a laser card after making the calculated adjustment.

Start the installation of the grid system with two main beams. These main beams must extend past the finished edges of the cloud ceiling. It is possible two main beams will need to be snapped together depending on the size of the cloud. The first main beams must be located so the rout holes will be in the proper position for the grid pattern. This is why the layout and cross tee installation starts from the middle

of the cloud and works outwards. It may be beneficial to place the initial main beams on the floor layout and mark the rout hole locations for the grid pattern.

Place two bent hanger wires into their respective hanger holes along the ends of the each main beam. Insert two 4' cross tees between the two main beams at the locations according to the floor layout. Attach two diagonal braces to the structure 90° to one another, above a location where the 4' cross tee intersects with the main beam. This intersection is called a node point. Repeat this process at the opposite end of the main beams at an opposing node point. See Figure 32.

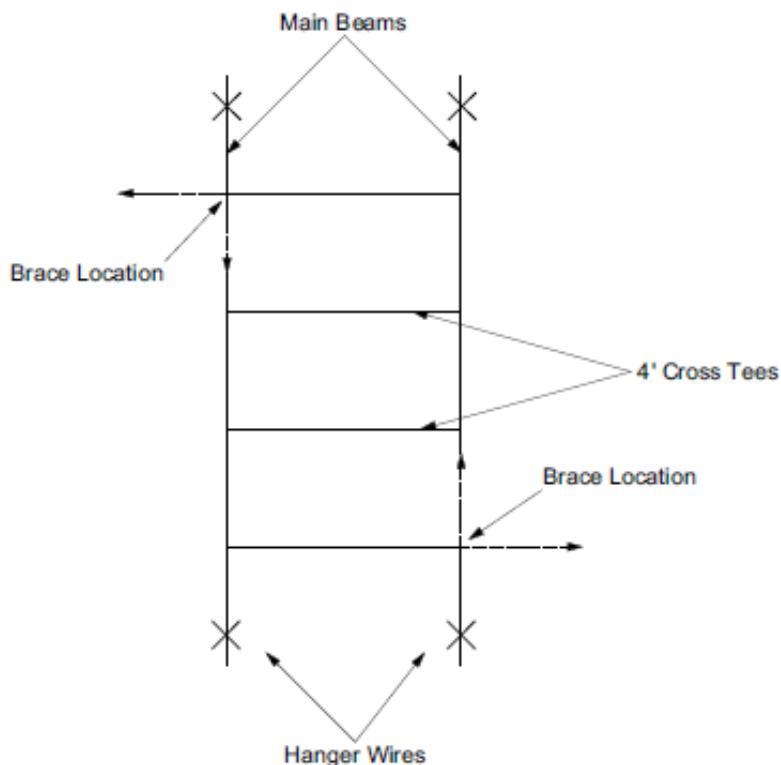

*Figure 32 - Diagonal Brace Locations*

Confirm the node point is in the proper position according to the floor layout by the use of a laser. Clamp both diagonal braces securing the alignment in both directions to the floor layout. Clamp the diagonal braces at a node point on opposing end of the main beams. Diagonally measure the grid to ensure the grid is square, adjust the diagonal braces if necessary and permanently attach the braces to the grid.

Install the remainder of the grid to a size larger than the finished size of the cloud. Cross braces can be installed on top of the grid, if necessary, to maintain square as the installation progresses. Level the grid and completely tie off the grid. Installers

should keep in mind how hanger wires impact the visual appeal of a cloud ceiling installation. Wire wraps should be tight and neat with the excess portion of the hanger wire trimmed. Hanger wires may be painted to blend into the background.

For small installations, the grid for the cloud can be installed on the floor, cross braced for square and raised into position. This would require more than one installer to raise the grid to prevent the grid from twisting. Before raising the grid, enough hanger wires should be bent at the proper elevation to support the grid. Cutting in the grid is explained in the following section.

### **Procedure – Installation of Main Beams and Cross Tees**

1. Set the laser to an elevation below the finished ceiling height.
2. Bend the main beam hanger wires at the required elevation by referencing the laser using a laser card.
3. Start the installation of the grid system with two main beams following the floor layout.
4. Place two bent hanger wires into their respective hanger holes along the ends of the each main beam.
5. Insert two 4' cross tees between the two main beams following the floor layout.
6. Attach two diagonal braces to the structure, 90° to one another, above a cross tee node point.
7. Repeat step 6 at the opposite end of the main beams at an opposing node point.
8. Confirm the node points are in the proper position according to the floor layout using a laser.
9. Clamp and attach the diagonal braces securing the alignment in both directions to the floor layout.
10. Diagonally measure the grid to ensure the grid is square, adjust the diagonal braces if necessary.
11. Install the remainder of the grid to a size larger than the finished size of the cloud.
12. Level the grid and completely tie of the grid.

### **Aluminum Perimeter Trim Installation**

The aluminum perimeter trim is initially installed on top of the leveled grid. Aluminum trim for circular or oval shaped clouds is bent at the factory. Temporarily assemble the aluminum trim on top of the grid, complete with splice plates. The alignment must be checked with the perimeter border dimensions shown on the floor layout or with the radius points. Clamp the assembled aluminum trim to the grid. Mark the top bulb of each intersecting grid component as shown in Figure 33. Two

marks are made, one will locate the initial alignment of the connector clips and the other is used to mark the location where the grid members are cut. It is recommended to mark the grid 1/4" past the connector clip alignment mark. This allows room for adjusting and aligning the grid during final assembly.

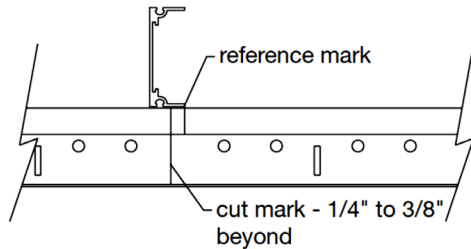

*Figure 33 - Reference Mark Locations*

Before removing the assembled aluminum trim, mark each piece of trim where a cross tee or main beam intersects the trim. These marks will be used to locate and realign the perimeter trim during final assembly. Remove the aluminum perimeter trim and cut the grid as marked.

### **Procedure – Cutting the Installed Grid**

1. Assemble the aluminum trim on top of the grid, complete with splice plates.
2. Align the aluminum trim to the floor layout using a laser.
3. Clamp the assembled aluminum trim to the grid.
4. Mark the top bulb of each intersecting grid component to locate the initial alignment mark for the connector clips.
5. Mark the top bulb of each intersecting grid component to locate where the grid members are cut.
6. Mark each piece of perimeter trim at a cross tee or main beam for realignment during final assembly.
7. Remove the perimeter trim.
8. Cut the grid at the mark made in step 5.

The next step is to install the connector clips onto the ends of the main beams and cross tees. Note how the end of the elongated hole is aligned with the alignment mark before the attachment is made as shown in Figure 34.

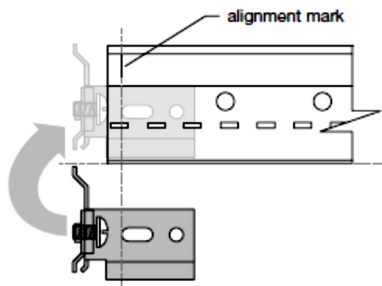

*Figure 34 - Clip Elongated Hole Alignment*

In some instances, the grid will rest on the flange of the aluminum perimeter trim and other times it is held up, depending on the edge detail for the ceiling tile. The primary difference is having the perimeter ceiling tile edge concealed by the aluminum perimeter trim or having the edge of tegular tile extending past the edge of the trim. The connector clip either flushes with the face flange, the top bulb or between the face flange and top bulb of the grid component. See Figure 35. Other times, a portion of the connector clip is cut using aviation snips for correct placement. Attach a connector clip to each grid component using a #8 x 9/16" sharp point screw inserted through the elongated hole. The elongated hole is used to adjust the aluminum trim once the connector clip is inserted into the boss.

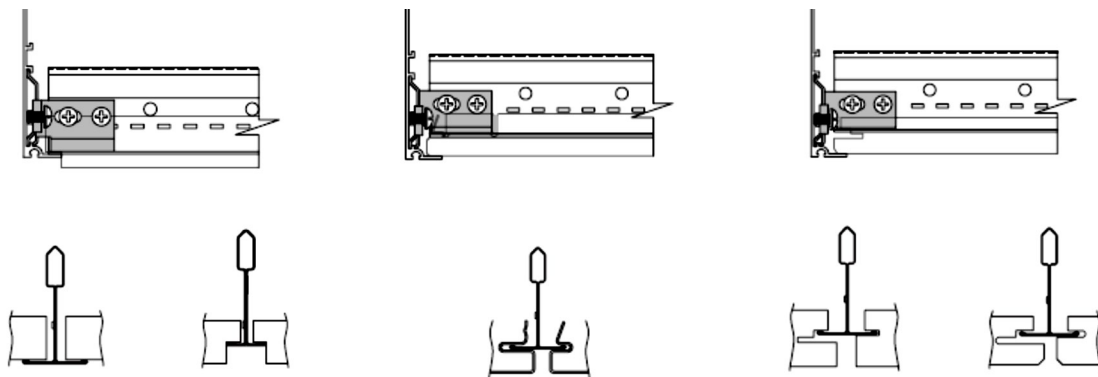

*Figure 35 - Connector Clip Placements*

Insert the splice plates into the boss in perimeter trim and insert the fabricated corners into the boss, if necessary. Hang the sections of aluminum trim onto the grid system by engaging the top ear of the connector clips under the boss of the trim. Slide the lower leg of the clips into the bottom portion of the boss. Check the alignment of the perimeter trim with the alignment marks made for the cross tee or main beam and secure the clips by tightening the locking screw. Repeat this process until all of the perimeter trim is installed. Slide the splice plates over to engage each piece of trim and tighten the Allen screws. Tighten the Allen screws for the fabricated corners or bent splice plates. Check the alignment of the perimeter trim



for straightness and insert a #8 x 9/16" sharp point screw in the remaining hole of each connector clip.

For perimeter trim over 10" in height, the aluminum trim must be braced. Straight sections are braced every 4' – 0" on center. A typical brace is shown in Figure 36. The brace is constructed from scrap grid material and a connector clip which is inserted into the boss of the trim. In addition, each trim piece over 10" in height must be supported by two independent wires attached to the structure. Each wire secures to the trim with a clip inserted into a boss.

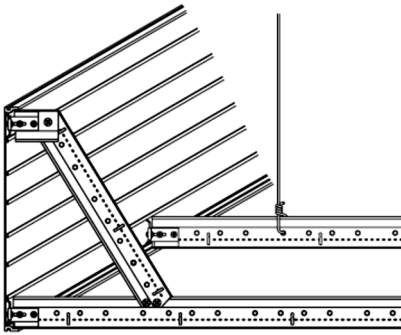
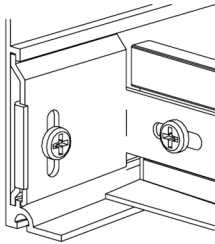

*Figure 36 - Braced Perimeter Trim*

### **Procedure – Installation of the Perimeter Trim**

1. Confirm the ceiling tile edge detail using the drawings for installation of the connector clips.
2. Install the connector clips onto the ends of the main beams and cross tees, using one #8 x 9/16" sharp point screw, after aligning the elongated slot with the clip alignment mark.
3. Insert the splice plates into the boss in perimeter trim along with the fabricated corners, if necessary.
4. Hang the first section of aluminum trim onto the grid system by engaging the top ear of the connector clips under the boss of the trim.
5. Slide the lower leg of the clips into the bottom portion of the boss. See Figure 37.
6. Confirm the alignment of the perimeter trim with the alignment marks for the cross tee or main beam.
7. Secure the connector clips to the trim by tightening the locking screw.
8. Repeat steps 4 through 7 until all perimeter trim is installed.
9. Slide the splice plates over to connect each trim piece and tightening the Allen screws.

10. Tighten the Allen screws at the corner splice plates or fabricated corners.
11. Check the alignment of the perimeter trim for straightness.
12. Insert a #8 x 9/16" sharp point screw in the remaining hole of each connector clip to secure the trim.



*Figure 37 - Engaged Connector Clip in Boss*

### **Stick Framed Installation – Precut Method**

All grid components for a stick framed cloud ceiling can be calculated for length. Components for a stick framed square or rectangular cloud can be converted into a kit cloud by cutting the standard length components ahead of time, thus saving time during installation. The finished edges of the cloud ceiling are snapped on the floor and the grid pattern is laid out. The length of the grid components, main beams, cross tees and perimeter trim pieces, are calculated based on the size of the cloud. The length of the cross tees and main beams must take into account the size of the perimeter trims' bottom flange.

For example, the profile of the perimeter trims' bottom flange measures 3/4" overall. The bottom flange is where the ceiling tile rests when installed along the perimeter edges of the cloud. The curved portion, on the inside of the bottom flange, measures 5/16" from the outside of the trim as shown in Figure 38. Therefore, a 8' x 8' square cloud, with a 2' x 2' grid pattern, is sized 8' – 0 5/8" x 8' – 0 5/8" outside to outside for the perimeter trim. The 5/8" allowance takes into account the thickness of the aluminum and the amount of the curved portion on the inside of the bottom flange. Oversizing the ceiling by 5/8", 5/16" on each side, permits full sized tiles to rest flat on the perimeter trim, without having to cut the tiles.

Some contractors may order fabricated inside and outside corner post as shown in Figure 39 and 40. These corners are factory mitered and assembled; therefore the aluminum trim components are straight cut to fit the corner posts. The dimensions of the corner posts are taken into consideration for both inside and outside corners. If the dimensions of an outside or inside corner post are 1" in both directions, 2" would be subtracted from the overall dimension. For example, for a 8' – 0 5/8" x 8' – 0 5/8" cloud, subtract 2" from 8' – 0 5/8" for each side of the cloud. The length of

each straight piece perimeter trim would be  $7' - 10 \frac{5}{8}"$ . If corner posts are not used, miter cut the aluminum trim to the overall dimensions of  $8' - 0 \frac{5}{8}"$ .

Main beams are cut  $\frac{1}{8}"$  less on each end. For an  $8' \times 8'$  cloud ceiling, the main beams are cut  $95 \frac{3}{4}"$  and the cross tees are cut to permit  $\frac{1}{8}"$  movement. Cutting these grid components slightly shorter allows for adjusting and squaring the grid. Once the components are cut to length, they are installed in the same manner as a cut-in ceiling. The node points are aligned with the floor layout and the grid is braced.

The first cross tee or main beam location is  $24 \frac{5}{16}"$  from the outside of each corner of the perimeter trim for square and rectangular cloud ceilings. This measurement is to the centerline of the cross tee or main beam in both directions. The remaining field cross tees and main beams are 24" on center. The trim is marked on the inside of the trim to locate the connector clips, which pinpoints the remaining cross tees and main beams. Installation of a precut cloud ceiling grid follows the same procedures as a cut-in cloud ceiling, however the components are cut to length before installation. Installation of the perimeter trim follows the same procedures as a cut-in cloud ceiling.

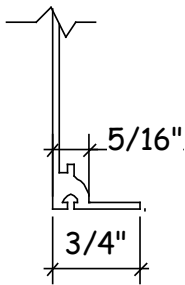

Figure 38 - Perimeter Trim Dimensions

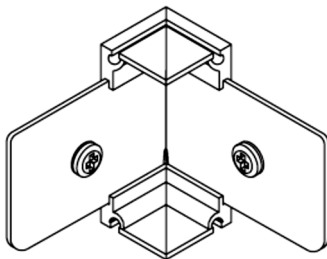

Figure 39 - Fabricated Outside Corner

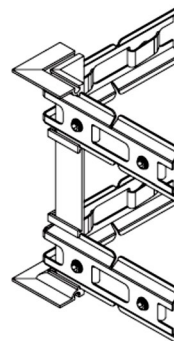

Figure 40 - Fabricated Inside Corner

## **Ceiling Tile Installation and Final Cleaning**

The ceiling tile installation for a stick framed cloud ceilings follows the same protocol as kit cloud ceilings and is not repeated in this chapter. The final cleaning will follow the same protocol as well.

## Chapter 2

### Study Guide

Directions:

Answer the following questions using the bubble answer key.

- 1) Hanger wires should extend a minimum of \_\_\_\_\_" past the horizontal installation height of the cloud ceiling for a proper three wrap tie.
  - A. 8
  - B. 10
  - C. 12
  - D. 14
  
- 2) Confirm the node point is in the proper position according to the \_\_\_\_\_ layout by the use of a laser during installation.
  - A. floor
  - B. ceiling
  - C. print
  - D. diagonal
  
- 3) The floor layout is used to measure and cut the perimeter trim to length, taking into account for corner post dimensions if they are used.
  - A. True
  - B. False
  
- 4) The primary difference when placing a connector clip for installation is the edge detail of the perimeter ceiling tile.
  - A. True
  - B. False
  
- 5) For straight perimeter trim over \_\_\_\_\_" in height, the trim must be braced 4' – 0" on center.
  - A. 8
  - B. 10
  - C. 12
  - D. 16

- 6) Kit clouds have proven to be up to 55% faster to install than stick framed clouds.
- A. True
  - B. False
- 7) Northern California requires each main beam to have a hanger wire within \_\_\_\_\_" of the cut ends and hanger wires spaced \_\_\_\_\_' on center or less from the ends.
- A. 6, 2
  - B. 8, 3
  - C. 8, 4
  - D. 10, 4
- 8) Stick framed cloud ceilings are diagonally checked for square.
- A. True
  - B. False
- 9) The grid for a stick framed cloud ceiling can be installed \_\_\_\_\_ than the size of the finished ceiling.
- A. smaller
  - B. larger
- 10) The aluminum trim is temporarily assembled on top of the grid, complete with splice plates, before aligning the trim with the floor layout for cut-in installations.
- A. True
  - B. False
- 11) The reflected ceiling plan is referenced to confirm the grid pattern, and grid type before installation.
- A. True
  - B. False
- 12) Heavy duty main beams for a stick framed ceiling are spaced \_\_\_\_\_ on center.
- A. 3' – 0"
  - B. 3' – 6"
  - C. 4' – 0"
  - D. 2' – 0"

- 13) Cross tees over 8" in length require a hanger wire placed within 8" of the cut ends.
- A. True
  - B. False
- 14) The alignment of the perimeter trim must be checked with the floor layout before the grid is marked and cut for cut-in installations.
- A. True
  - B. False
- 15) Splice plates are inserted into the channel boss of the perimeter trim before final assembly.
- A. True
  - B. False
- 16) It is not necessary to locate the main beams and cross tees on the floor layout for a stick framed cloud ceiling.
- A. True
  - B. False
- 17) Aluminum perimeter trims 10", 12", 14" and 16" in height must be supported directly from the \_\_\_\_\_ with two hanger wires per piece of trim.
- A. grid
  - B. structure
  - C. brace
  - D. floor
- 18) Two marks are made on the grid before cutting, one will locate the initial alignment of the \_\_\_\_\_ and the other is used to mark the location where the grid members are cut.
- A. splice plates
  - B. fabricated corners
  - C. connector clips
  - D. perimeter trim
- 19) Cross tees located on each side of a perimeter trim splice joint require a hanger wire regardless of their length.
- A. True
  - B. False

20) A \_\_\_\_\_" tolerance is made when cutting the main beams and cross tees to size, which allows for aligning and adjusting the perimeter trim.

- A. 1/8
- B. 1/4
- C. 1/2
- D. 3/4



## Chapter 3

# Acoustical Canopies and Vertical Blades

### Objectives:

Upon completion of this chapter, students will be able to:

- 1) Explain the differences between acoustical canopies and vertical blades.
- 2) Layout acoustical canopies and blades based on the project drawings.
- 3) Install acoustical canopies and vertical blades.

### Introduction

This chapter introduces acoustical canopies and vertical blades. Acoustical canopies and blades define spaces and enhance the acoustics of an open plenum space. Similar to clouds, canopies and blades utilize both the front and back surfaces to provide greater sound absorption than a continuous ceiling. These products significantly reduce background noise and reverberation. Existing open plenum spaces are often retrofitted with canopies and blades to achieve sound reduction objectives.

### Sizes and Shapes

Acoustical canopies can be manufactured in a variety of shapes, sizes and configurations and install horizontally or on an angle. This chapter introduces the basic shapes and sizes most commonly found for interior spaces. Basic canopy sizes are flat 4' x 4', 4' x 8' and a curved 3' x 3', 4' x 6'. Flat canopies are a nominal 1 1/2" thick and curved canopies are a nominal 1 1/8" thick. See Figure 40 for shapes and sizes. Canopies can be custom painted, but usually have a standard white applied paint finish.

Blades install vertically and are either 10" or 22" in height, with a length of 46" or 94". The thickness of a blade is 2". Configurations of a blade installation are most often governed by the size of the space. The blade color often matches or accents the wall colors. Neither canopies nor blades can be cut, drilled or altered in any way.

Canopies and blades are carefully packaged and protected by the manufacturer. It is never recommended to remove a canopy or blade from the protective packaging until it is going to be installed. Always replace any protection removed during installation. Protection is removed at the appropriate time before the space is turned over to the tenant.

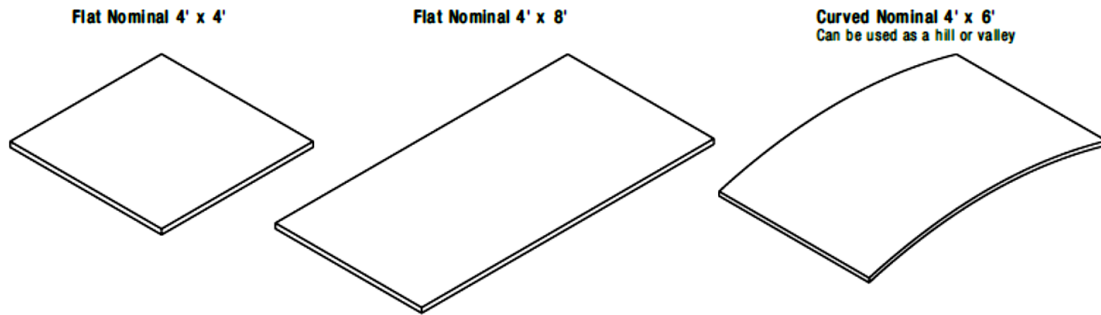

Figure 41 - Canopy Sizes and Shapes

## Components

Canopies and blades have minimal components as compared to a conventional acoustical ceiling. The major component of a canopy is the canopy itself, along with the hanging hardware. In Figure 41, canopy hanging hardware is shown. This hardware consists of aircraft cable, and a top and bottom cable assembly, with the top assembly used for adjusting the height of the canopy. There are two possible types of anchors for the bottom assembly which attaches the aircraft cable to the canopy. One method uses a hook and spiral anchor as shown in Figure 42 and the other method uses a screw in cap as shown in Figure 41. 3' x 3', 4' x 4' and 4' x 6' canopies require four cable assemblies and 4' x 8' utilize six cable assemblies.

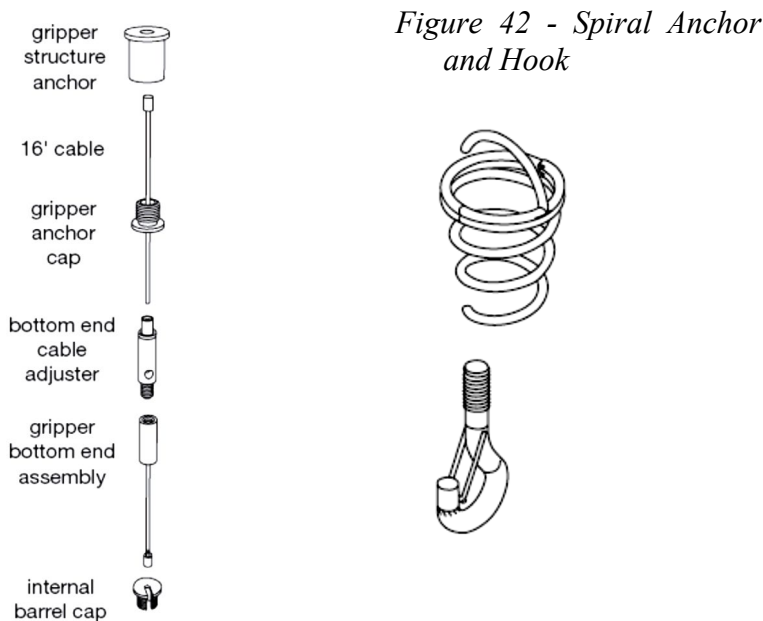

Figure 42 - Spiral Anchor and Hook

Figure 41 - Canopy Hanging Hardware

The major component for a blade system is the blades. Figure 43 shows the shape and sizes for 10" blades and Figure 44 shows the size and shape for 22" blades.

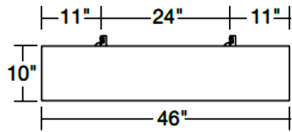

Figure 43 - 10" Blades

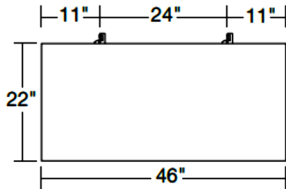
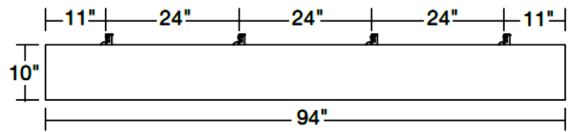
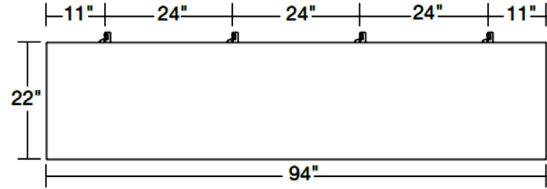

Figure 44 - 22" Blades



Blades have two mounting options. One method uses either 12 gauge hanger wire or aircraft cable attached to the structure. Wires directly tie to the blades at the factory embedded mounting tabs or cables attach with a crimp or quick loop connector as shown in Figure 45. The other method, utilizes heavy duty main grid system hung from the structure and the mounting tabs are inserted into a rout hole or bent and screwed to the web of the main beams as shown in Figure 46. The canopies and blades are separated in the following sections because of the installation differences.



Figure 45 - Embedded Clip



Figure 46 - Screw Attached Embedded Clip

## Canopy Installation

As with any installation, the construction drawings are referenced to locate the information related to the installation. The positions of the canopies are located, with the proper clearances noted between each canopy and other objects such as the perimeter walls. The mounting height is noted and adjusted if necessary based on the floor finishes. Canopies and blades should be one of the last items installed on

the job site due to the nature of the material and the painted finish. These items cannot be easily repaired if damaged during installation or otherwise.

## Canopy Layout

Layout for a canopy is similar to a cloud layout in that the exact location of the hanger cables must be located and transferred to the above structure. The finished size of the canopy is snapped on the floor and the hanger cable locations are marked. Depending on the overhead structure, backing or trapeze framing may be required to properly locate the hanger cables. Figure 47 shows the factory specified cable locations for each canopy size.

In most instances, these locations are factory marked on the canopy or the female portion of the screw-in cap is embedded into the canopy at the factory. When a series of canopies are installed, each individual canopy is laid out to locate the cable locations. A floor layout should look very similar to Figure 47, with all hanger cable locations marked. The on center spacing of the cable locations would not be required, however location marks are required for aligning a plumb laser.

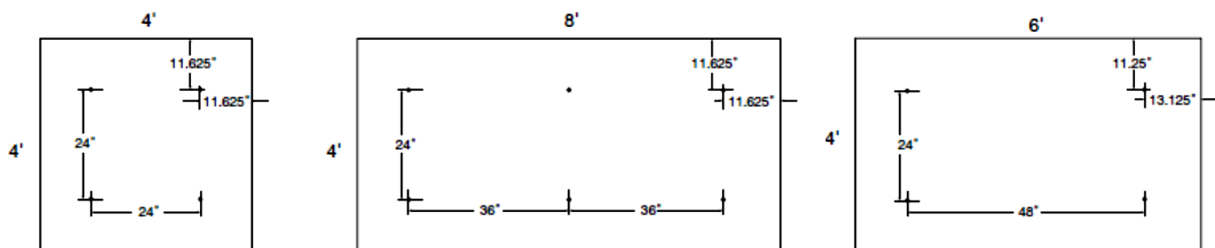

Figure 47 - Canopy Cable Locations

## Hanger Cable Installation

The marks produced for each hanger cable during the layout process are transferred to the structure above by the use of a laser. It is best to maintain each hanger cable in a plumb position, however never exceed the 6:1 ratio, unless another counter acting cable is installed.

The anchor for attaching the cable to the building structure is supplied by subcontractor doing the work. Depending upon the situation, this could be an expansion anchor or threaded connection depending upon the composition of the building structure. Always follow the instructions supplied by the anchor manufacturer for installation.

The gripper structure anchor of the top cable assembly is attached at the mark with the appropriate anchor. The gripper could be screw attached onto an expansion

anchor or screwed directly to the structure. The next step is to thread the aircraft cable through the gripper anchor cap and completely screw the cap into the gripper structure anchor. The aircraft cable hangs freely at each anchor and the bottom cable assembly is attached to the canopy before raising the canopy and attaching both assemblies together as shown in Figure 48.

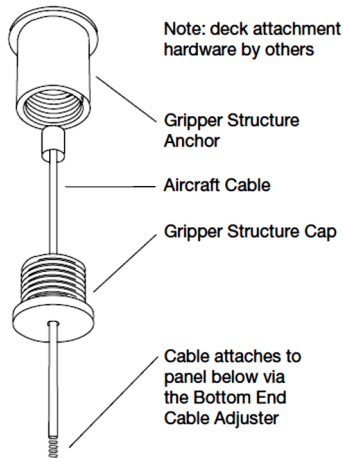

Figure 42 - Gripper Structure Anchor

### Canopy Installation - Screw in Cap

This installation addresses the screw in cap method. Although, this method is similar to the spiral anchor method there are differences which must be noted. The spiral anchoring method follows this section. The bottom end cable assembly is attached to the canopy, see Figure 49, while the canopy is in the factory supplied shipping carton. The canopy is not removed from the carton until it is raised into position to prevent damage.

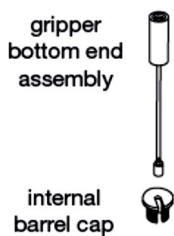
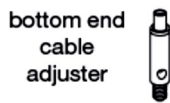

Figure 49 - Bottom End Cable Assembly

The factory packaging is removed on top of the canopy and the plastic covering is pulled back to expose the embedded female connectors. The bottom end cable assembly is slid into the male cap and the cap is completely screwed into the female connectors embedded on the backside of the canopy. The bottom end cable adjuster

is screwed into the gripper bottom end cable assembly, see Figure 50. This process is repeated until all bottom cable assemblies have been attached to the canopy.



*Figure 50- Bottom End Cable Adjuster*

The carton containing the canopy is moved to the approximate location of the installation and is kept on a flat and level surface. The end of each hanger cable from the structure is threaded through a cable adjuster at each location and the slack in the cable is removed by gently pulling on the cable. Do not remove the corner protectors before suspending the canopy.

A laser is set to a comfortable measuring distance below the actual mounting height of the canopy. Two installers are required to raise the canopy into position. It is recommended to use white cotton gloves or to have clean hands. The canopy is raised and the cables are gently pulled through the cable adjusters. Do not pull the cables through the adjusters without alleviating the weight of the canopy first or damage to the cables may occur. The canopy is raised until the mounting height is achieved and confirmed with the laser. Cut the excess cable with-in 2" of the cable adjuster as shown in Figure 51. The canopy can be lowered, if needed, by taking the weight off of the cables and depressing the plunger on top of the cable adjuster.

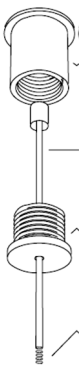

*Figure 51 - Completed Cable End Assembly*

### **Procedure – Installation of a Embedded Anchor Canopy**

1. Gather the information necessary from the reflected ceiling plan to locate the canopy.
2. Snap the lines representing the finished perimeter edges of each canopy.
3. Mark the hanger wire/cable locations for each canopy.
4. Transfer the hanger/cable marks to the structure above using a plumb laser.
5. Attach the gripper structure anchor of the top cable assemblies using the appropriate fastener.

6. Thread the aircraft cables through the gripper anchor caps and completely screw the caps into the gripper structure anchors. See Figure 52.
7. Removed the factory packaging on top of canopy in box.
8. Pull back and the plastic covering exposing the embedded female connectors.
9. Thread the bottom cables into the male caps and screw the caps completely into the female connectors. See Figure 53.
10. Screw the bottom end cable adjusters into the bottom cable assemblies.
11. Move the carton containing the canopy to the approximate installation location keeping it flat and level.
12. Thread the end of each hanger cable through a cable adjuster and remove the slack in the cable.
13. Set a laser to a comfortable measuring distance below the actual mounting height of the canopy.
14. Provide slack in the cables by alleviating the weight of the canopy.
15. Raise the canopy, with two installers using use white cotton gloves, by pulling the cable through the cable adjusters.
16. Confirm the mounting height is achieved with the laser.
17. Replace the plastic covering over the cloud and replace corner protection if necessary.



*Figure 52 – Gripper  
Structure Anchor  
Assembly*



*Figure 53 - Bottom End Cable  
Assembly*

## **Final Adjustments and Precautions**

Once the canopy has been raised in the final position, the excess aircraft cable is cut, leaving about 2" remaining out of the cable adjuster. The plastic protection and the edge guards should be left in place until the other trades have completed their work in the area. This should keep the canopy clean and hopefully minimize any edge damage. In addition, pictures should be taken of the undamaged and completed installation for record.

## Canopy Installation – Spiral Anchor

The spiral anchor installation is the same as the screw in cap installation in regards to the layout and installation of the hanger cables. How the cables attach to the canopy is the difference. Canopies with spiral anchors are laid out and attached at the points shown in Figure 54. The spiral anchors are twisted in a clockwise motion into the back of the canopy.

### HANGING AND HARDWARE PLACEMENT

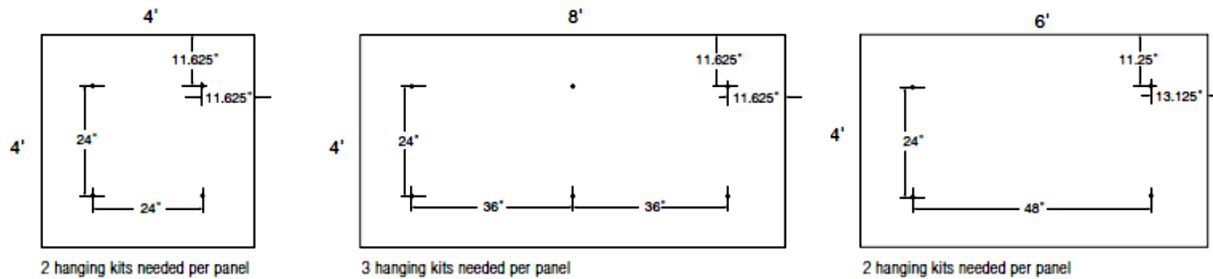

Figure 54 - Spiral Anchor Attachment Points

The canopy is not removed from the shipping box until after the cable assembly has been attached at the installation area. The canopy is kept level before it is raised into position. The free end of the hanger cable is inserted into the cable adjuster and the slack in the cable is gently removed by pulling on the cable. The next step is to screw the locking finishing hook into the bottom of the cable adjuster. The finishing hook is clipped to the exposed portion of the spiral anchor for all connections, before the canopy is raised into position.

A laser is set in the same manner as mentioned before and the canopy is raised into position while alleviating the canopy weight from the cables. Two installers, with clean hands or with white cotton gloves, are required to raise the canopy. The canopy can be adjusted lower by releasing the plunger of the cable adjusters one at a time. The final adjustments and precautions are the same for these canopies.

### Procedure: Installation of a Spiral Anchor Canopy

1. Repeat steps 1-7 of the “Embedded Anchor” procedure.
2. Pull back and the plastic covering exposing the spiral anchor locations or layout if necessary.
3. Twisted the spiral anchors in a clockwise motion into the back of the canopy at the marks made in Step 2.
4. Insert the free end of the hanger cables into the cable adjusters and remove the slack by pulling on the cable ends.



5. Screw the finishing locking hooks into the bottom of the cable adjusters. See Figure 55.
6. Set a laser to a comfortable measuring distance below the actual mounting height of the canopy.
7. Provide slack in the cables by alleviating the weight of the canopy.
8. Raise the canopy, with two installers using use white cotton gloves, by pulling the cable through the cable adjusters.
9. Confirm the mounting height is achieved with the laser.
10. Replace the plastic covering over the cloud and corner protection if necessary.

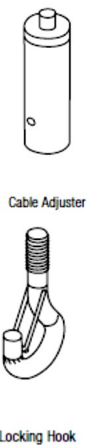

*Figure 55 - Cable Adjuster and Locking Hook*

## **Blade Installation**

There are two options available for installing vertical blades. The construction drawings are referenced for details as to the mounting option the architect has chosen. Blades can be direct mounted with the use of 12 gauge hanger wire or aircraft cable or attached to a heavy duty grid system. When blades are attached to a grid system, the grid system must be heavy duty rated and installed in accordance with the local codes and seismic category requirements for wall to wall ceilings. This includes wall angle, main beams and cross tees, as well as compression posts and lateral force bracing as detailed on the construction drawings.

### **Blade Layout – Direct Mount**

Layout dimensions for direct mount blades are gathered from the construction drawings. This includes the spacing between the individual blades and surrounding features such as walls, soffits or other ceilings. The installation height is also noted. Notice in Figure 56, the location of the hanger wires or cables varies based on the length of the blade. The hanging points start 11" from the ends and 24" on center.

Consequently, the finished edges of each blade are laid out and the hanging points are marked for each blade. These marks are transferred to the structure above with the use of a plumb laser.

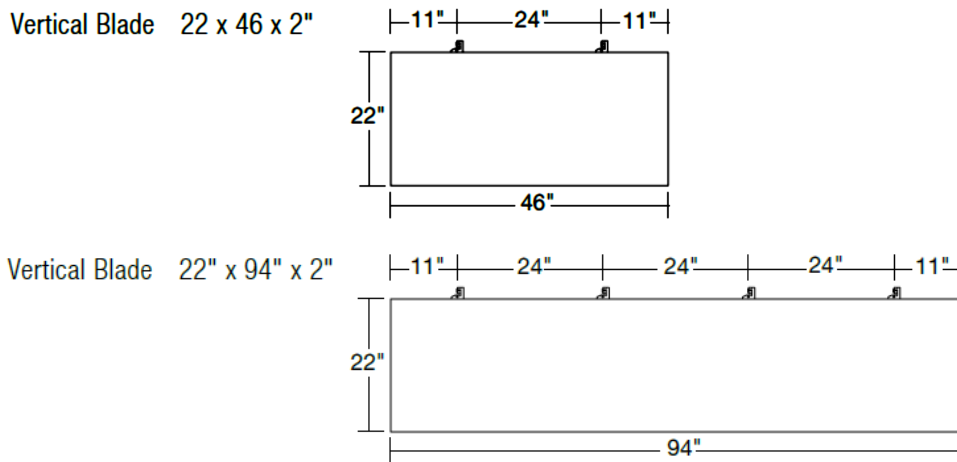

Figure 56 - Hanger Wire or Cable Locations

### Installation of Hanger Wire or Cable

The hanger wires or cables attach with appropriate fastener at the locations marked on the structure. Complete the installation of the wires or cables, however, care should be taken to avoid damaging the blades with the hanger wires during installation. The hanger wires are bent at a calculated point as determined by measuring from the bottom of the blade to the mounting hole in the anchor at the top of the blade. For instance, if the installation height to the bottom of the blade is specified at 9' - 0" A.F.F. and the blade has a height of 11 1/2" to the mounting hole, each hanger wire would be bent at 9' - 11 1/2". If quick loop connectors are being used, the bottom of the quick loop connectors would be set at approximately 9' - 11 1/2" or the cable marked at this location. The anchors, which are embedded into the top of each blade, are designed for attaching to a grid system, hanger wire or cable. When the attachment is by hanger wire or cable, the top portion of the anchor is removed with aviator snips before installation.

### Installation of Blades – Direct Mount

It is best to have two installers with white cotton gloves raise 94" blades and tie the hanger wires or insert the aircraft cable into the quick loop connectors after setting up the laser. The hanger wires are inserted into the end anchors on the blade first and then the remaining wires or cables are installed. The installation progresses until complete, with each blade checked for level using the laser. A three wrap tie is required for hanger wires, with the excess portion trimmed. For aircraft cable, the

quick loop connector is held in place and the slack in the cable is removed by pulling on the free end of the cable. Any excess aircraft cable is trimmed to provide a neat appearance. Blades cannot be field cut for penetrations.

### **Procedure – Installation of Direct Mount Blades**

1. Gather the information necessary from the reflected ceiling plan to locate the blades.
2. Snap the lines representing the finished perimeter edges of each blade.
3. Mark the hanger wire/cable locations for each blade.
4. Transfer the hanger/cable marks to the structure above using a plumb laser.
5. Install the hanger wires/cables using the appropriate fastener.
6. Bend the hanger wires or install a quick loop connector at the calculated location for each hanger.
7. Remove the top portion of each embedded anchor.
8. Remove the blade from the shipping box with white cotton gloves.
9. Insert a hanger wire/cable into the end embedded anchors on the blade.
10. Check the blade for level using a laser.
11. Tie the hanger wires with a three wrap tie or remove the slack in the cable while holding the connector in place.
12. Complete attaching the hanger wire/cable for the remaining anchors.
13. Complete the installation of the remaining blades.

### **Blade Layout – Heavy Duty Suspension System**

Determine the spacing and location of the blades from the construction drawings, including the mounting height. The embedded anchors on the top of each blade are made to insert into a rout hole of the main beams or the anchor can be bent 90° and attached to the web of a main beam as shown in Figure 57. The layout of the grid system can be done in two ways, where the rout holes align with the embedded anchors or where the anchors attach to the web of the main beams at the specified location without concern for the rout hole locations. The construction drawings and details should be checked for the attachment method.



*Figure 57- Attached Anchor Clip*

### **Installation of Blades – Suspension System**

Install the grid suspension system as normal, complete with seismic bracing and lateral restraint. The grid system requires the main beam spacing to match the embedded anchors, which is 11" from the end of each blade and 24" on center between the ends. Layout each blade location on the grid system and snap chalk lines to locate the embedded anchors or identify the rout holes where the anchors will insert if the grid was installed for insertion of the anchors.

Remove the blade from the factory shipping container using white cotton gloves. The embedded anchors are bent to a 90° angle with a pair of linesman pliers when the anchor is screwed to the main beam web. Align the blade with the chalk line and clamp two end anchors to the main beams. Insert a #8 x 9/16" sharp point screw connecting each anchor to the web of the main beam. For installations where the anchor is inserted into a rout hole, the tab is bent and attached with one #8 x 9/16" sharp point screw after the tab is inserted through the rout hole. There should not be a need to check level if the suspended ceiling supporting the blades is level.

### **Procedure – Installation of Blades on a Suspended Grid System**

1. Gather the information necessary from the reflected ceiling plan to locate the blades.
2. Determine the attachment method to the suspended grid system.
3. Layout the grid system, adjusting for the height of the blades being installed and for the blade attachment method.
4. Install the grid system, complete with seismic bracing and lateral restraint.
5. Layout the blades on the grid system by snapping lines locating the placement of the embedded anchors.
6. Remove the blade from the shipping box with white cotton gloves.
7. Bend the anchors 90° for attachment to the web of the main beams, if necessary.

8. Clamp the blade to the grid system at the two end anchors or insert the anchors into the proper rout holes.
9. Check the alignment with the chalked layout line and insert a #8 x 9/16" sharp point screw through each anchor into the web depending on the application.
10. Bend the inserted anchor at each rout hole and insert a #8 x 9/16" sharp point screw through each anchor into the web depending on the application.
11. Complete the installation of the blades until complete.

### Chapter 3 Study Guide

Directions:

Answer the following questions using the bubble answer key.

- 1) Similar to clouds, canopies and blades utilize both the front and back surfaces to provide greater sound absorption than a continuous ceiling.
  - A. True
  - B. False
  
- 2) Layout for a canopy is similar to a cloud layout in that the exact \_\_\_\_\_ of the hanger cables must be located and transferred to the above structure.
  - A. angle
  - B. height
  - C. attachment
  - D. location
  
- 3) The bottom end cable assemblies are attached to the canopy while the canopy is in the factory supplied shipping box.
  - A. True
  - B. False
  
- 4) Is it acceptable to cut pipe penetrations in canopies when necessary.
  - A. True
  - B. False
  
- 5) When a series of canopies are installed, each individual canopy is laid out to locate the \_\_\_\_\_ locations.
  - A. corner
  - B. cable
  - C. beam
  - D. perimeter
  
- 6) Before a canopy is suspended, the plastic protective covering and corner guards are removed.
  - A. True
  - B. False

- 7) \_\_\_\_\_ can be direct mounted with the use of 12 gauge hanger wire or aircraft cable or attached to a heavy duty grid system.
- A. Canopies
  - B. Clouds
  - C. Blades
  - D. Tiles
- 8) Canopies and blades should be one of the last items installed on the jobsite due to the nature of the material and the painted finish.
- A. True
  - B. False
- 9) There are three possible types of anchors for the bottom assembly which attaches the aircraft cable to the canopy.
- A. True
  - B. False
- 10) A canopy can be lowered, if needed, by taking the weight off of the canopy and depressing the plunger on top of the cable \_\_\_\_\_.
- A. component
  - B. adjuster
  - C. hook
  - D. assembly
- 11) The anchors, which are embedded into the top of each blade, are designed for attaching to a grid system, hanger wire or cable.
- A. True
  - B. False
- 12) A \_\_\_\_\_ wrap tie is required for hanger wires, with the excess portion trimmed for a canopy or blade installation.
- A. one
  - B. two
  - C. three
  - D. four
- 13) 3' x 3', 4' x 4' and 4' x 6' canopies require four cable assemblies and 4' x 8' utilize six cable assemblies.
- A. True
  - B. False

- 14) Spiral anchors are twisted in a counter clockwise motion into the back of the canopy.  
A. True  
B. False
- 15) A finishing hook is clipped to the exposed portion of the spiral anchor before the canopy is raised into position.  
A. True  
B. False
- 16) When blades are attached to a grid system, the grid system must be heavy duty rated and installed in accordance with the local codes and seismic category requirements for wall to wall ceilings.  
A. True  
B. False
- 17) When attaching a blade to hanger wire or cable, the top portion of the embedded \_\_\_\_\_ is removed with aviator snips before installation.  
A. anchor  
B. wire  
C. blade  
D. cable
- 18) A grid system used to suspend blades, requires the main beams be installed at \_\_\_\_\_" from the end of each blade and \_\_\_\_\_" on center between the ends.  
A. 6, 12  
B. 8, 12  
C. 6, 24  
D. 11, 24
- 19) The embedded anchors in the top of each blade are made to insert into a rout hole of the main beams or the anchor can be bent 90° and attached to the web of a main beam.  
A. True  
B. False
- 20) A #8 x 9/16" self - drilling screw is acceptable for attaching the embedded anchors to the web of main beams for blade installations.  
A. True  
B. False